

United States Department of the Interior
Bureau of Land Management
Cadastral Survey

Specifications for Descriptions of Land:

For Use in Land Orders, Executive Orders, Proclamations,
Federal Register Documents, and Land Description Databases

BLM



Revised 2015





Specifications for Descriptions of Land:

For Use in Land Orders, Executive Orders, Proclamations,
Federal Register Documents, and Land Description Databases

Produced in coordination with the
Office of Management and Budget,
United States Federal Geographic Data Committee,
Cadastral Subcommittee

Washington, DC: 2015
U.S. Department of the Interior

Suggested citation for general reference:

U.S. Department of the Interior. 2015. Specifications for Descriptions of Land: For Use in Land Orders, Executive Orders, Proclamations, *Federal Register* Documents, and Land Description Databases. Bureau of Land Management. Washington, DC.

Suggested citation for technical reference:

Specifications for Descriptions of Land (2015)

Find these Specifications and other information at www.blm.gov.

U.S. Department of the Interior

The mission of the Department of the Interior (Department) is to protect and provide access to our Nation's natural and cultural heritage and honor our trust responsibilities to Indian tribes and our commitments to island communities.

The Department works to assure the wisest choices are made in managing all of the Nation's resources so each will make its full contribution to a better United States—now and in the future.

The Department manages about 500 million acres, or one-fifth, of the land in the United States. The Bureau of Land Management (BLM), an agency within the Department, manages more than 245 million of these surface acres and also administers more than 700 million acres of subsurface mineral estate.

The BLM is the Nation's surveyor and maintains extensive current and historical information about land ownership in the United States. Most titles to land, public or private, begin with a land description established by an original cadastral survey. Security of legal title to land is the fundamental object of the cadastral surveyor's work.

Persons preparing land descriptions must be knowledgeable of the requirements for the various types of land descriptions. They must use the proper format, terms, and phrases and clearly state the intent, with qualification, to ensure the content of the land description is free of ambiguity. The ambiguous descriptions of the past are the boundary disputes of the future.



Contents

	Page
Introduction and Purpose	1
Data Content Standard	1
Land Orders	2
I. Land Descriptions	3
Purpose.	3
Authority.	3
Descriptions of Land	4
Types of Descriptions.	4
Reference to Official Records	5
II. The Public Land Survey System	7
Rectangular Surveys	7
Preferred Order	9
Preferred Method for Writing Descriptions	10
Area.	13
Conventional Symbols and Abbreviations	14
Examples of Descriptions of Lands Based upon the Rectangular Surveys of the Public Land Survey System.	15
III. Metes-and-Bounds Surveys.	19
Natural and Artificial Boundaries	19
Area.	20
The Parts of Metes-and-Bounds Descriptions	20
Strip Descriptions	26
Ambulatory Descriptions.	27
IV. Lot and Block Descriptions.	29
V. Illustrations (Maps) and Coordinates.	30
Maps to be Published	30
Survey Plats, Maps, or Diagrams Forming Official Supplements.	32
Description by Coordinates	32
Geographic Positions	32
Examples of Geographic Coordinate Positions	34
VI. Form and Arrangement	35
Executive Order No. 11030, as Amended—Preparation, Presentation, Filing, and Publication of Executive Orders and Proclamations	35
1 CFR 18.10—Illustrations, Tabular Material, and Forms.	35
1 CFR 19.1—Form	36
43 CFR 2300—Land Withdrawals, Reservations, and Classifications of Land	36
Department of the Interior Secretary’s Orders	37
Public Land Orders	37
Executive Order No. 13327—Federal Real Property Asset Management	37
Marine Managed Areas: Best Practices for Boundary Making.	37
Appendix: Introductions to Previous Editions	38

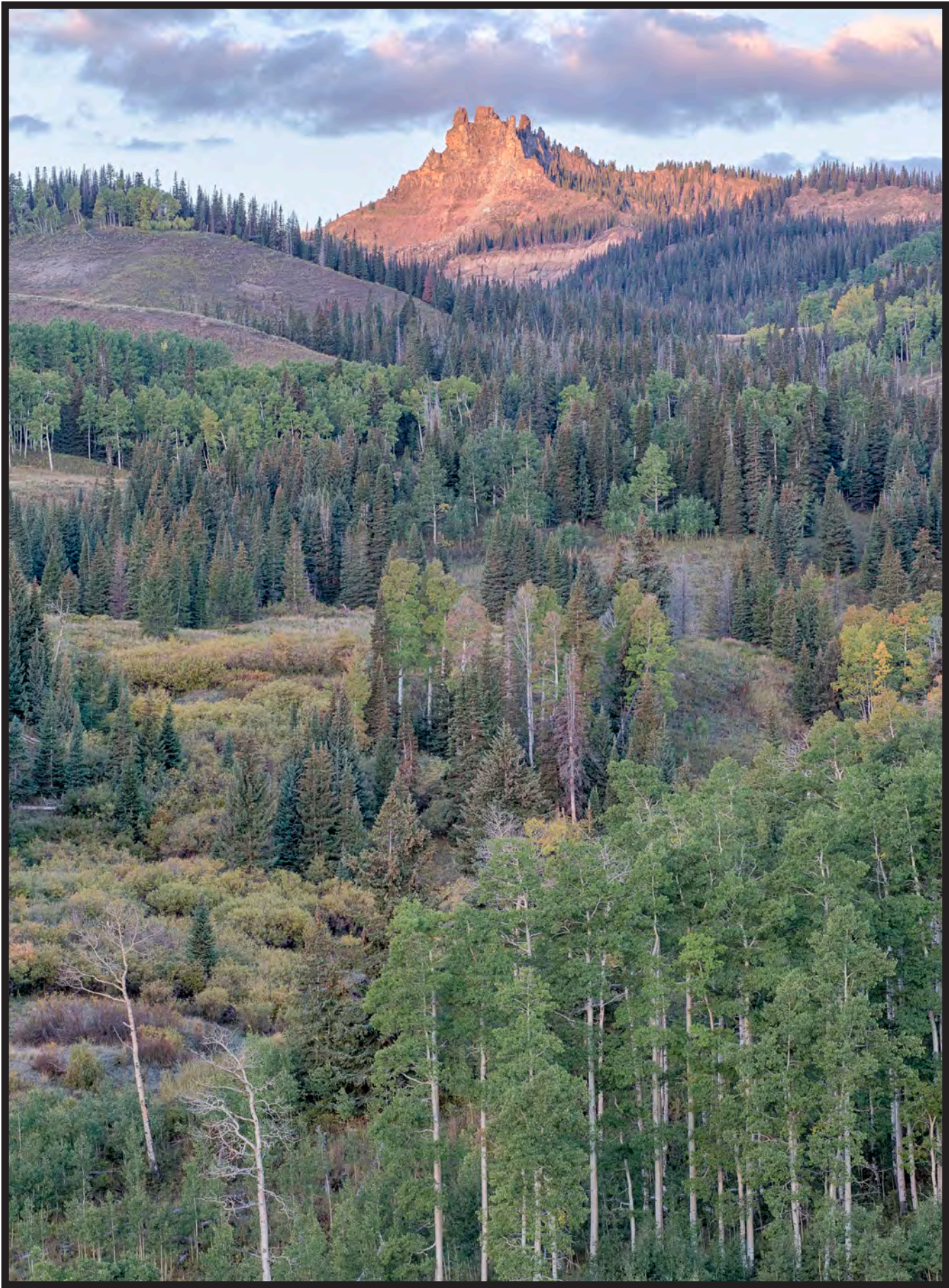



Introduction and Purpose

The Federal Board of Surveys and Maps (Board) was established by Executive order in 1919 to coordinate and promote improved surveying and mapping activities by Federal agencies. In 1930, the Department of State requested that the Board prepare rules and specifications for descriptions of tracts of land appropriate for use in Executive orders and proclamations. The original edition, *Specifications for Descriptions of Tracts of Land for Use in Executive Orders and Proclamations* (Specifications), was completed and published in 1931, with subsequent editions issued in 1941, 1942, 1960, and 1979 (see appendix). Since 1931, the Specifications have been used by those who must write and interpret land descriptions, including experts in the legal, survey, public administration, and geospatial data analyst professions.

Since the publication of the 1979 edition of the Specifications, the reorganization and transfer of functions of various Federal agencies¹ have rendered certain procedures inapplicable,

¹ The policies and procedures for publication in the *Federal Register* are established by the Administrative Committee of the *Federal Register*. The functions connected with the presentation of public land orders, Executive orders, and proclamations are carried on by the Office of the *Federal Register*, National Archives and Records Administration, under the provisions of the *Federal Register Act*, as amended, and the Administrative Procedure Act. The pertinent regulations are published in Title 1 of the Code of Federal Regulations.

prompting a revision to the Specifications. New survey and digital applications and methods also mandate this revision. Further experience in using the Specifications and improvements to survey and digital data collection since 1979 indicate the need for additional and updated explanations and examples. These revised Specifications supersede all previous Specifications on the technical subjects contained therein.

The Specifications provide guidance for writing accurate boundary descriptions and locations by survey, the form and arrangement to be followed for Executive and public land orders and proclamations, and examples of boundary descriptions. A boundary is the fixing of a limit or extent of property and, in this publication, is associated with uplands and inland waters and tidelands with application to marine boundaries. The Specifications also provide a standardized process for review of descriptions to assure that only the best available descriptions are published. When an executive department or any agency or establishment of the Federal Government describes or specifies any parcel of land or marine area by boundary or subdivisional unit, the description should be a model of precision, to the extent the available record data permit. A law, regulation, or order cannot fulfill its intent if the boundary description is inaccurate, vague, or ambiguous.

Data Content Standard

Many land descriptions are used to develop products for Federal administrative purposes. Accurate and precise geographic (or geospatial) information is critical to promote economic development, improve stewardship of natural resources, and protect the environment. Standardized land descriptions avoid wasteful duplication of effort and promote effective and economical management of land and resources by Federal agencies. The information in the *Specifications for Descriptions of Land* assures consistency with the Cadastral Data Content Standard for the National Spatial Data

Infrastructure² (NSDI) developed by the Federal Geographic Data Committee's Subcommittee for Cadastral Data in support of the requirements of the Office of Management and Budget (OMB) Circular No. A-16, revised.³

The Federal Geographic Data Committee (FGDC) was established by OMB's revised Circular No. A-16 to coordinate the Federal Government's development, use, sharing, and dissemination of geographic data. The FGDC Subcommittee for Cadastral Data developed the Cadastral Data Content Standard and the CadNSDI Publication Standard⁴ covering the development, maintenance, and dissemination of the core set of digital geospatial cadastral information (see section 2(b) (1), A-16), including descriptions of tracts of land. Core data is the minimal set of information needed for sharing data among agencies for initial search and discovery by the user community and use in basic business operations.

To facilitate the sharing of land description information in an electronic database format, all datasets should be accompanied with essential cadastral metadata that conforms to the FGDC geospatial metadata as refined for cadastral data.⁵ The Cadastral Data Content Standard provides the logical design definitions and relationship of land description elements. Physical implementations should be consistent and compliant with the Cadastral Data Content Standard definitions and intent.

Executive Order No. 12906, as amended, requires each agency to document all new geospatial data it collects or produces, using the standard developed by the FGDC.⁶ It also defines geospatial data as "information that identifies the geographic location and characteristics of natural or

constructed features and boundaries on the earth." The geospatial information necessary to describe the geographic extent of and the rights and interests in a tract of land includes surveys, legal description reference systems, parcel-by-parcel surveys, and descriptions.⁷

Land Orders

The term "land order," by common usage, has come to mean "Executive order" and "public land order." In the past, the terms "legal description" and "land description" were commonly used interchangeably. In reality, the "legal description" contains the "land description" within the legal document or order. The "legal description" also defines the use, purpose, encumbrances, and timeframe (four-dimensional) of the tract(s) being described. The actual "land description" defines the delimitation⁸ of an area of the subsurface, submerged lands, water column, water surface, land surface, or air column, and two-dimensional or three-dimensional limits.



² <http://nationalcad.org/projects/cadastral-data-standards-and-guidelines/>.

³ The revised Office of Management and Budget Circular No. A-16, entitled *Coordination of Geographic Information and Related Spatial Data Activities*, was issued August 19, 2002.

⁴ <http://nationalcad.org/projects/cadastral-data-standards-and-guidelines/>.

⁵ *Ibid.*

⁶ E.O. 13286 (02/28/03) 68 FR 10619 transferred certain functions to the Secretary of Homeland Security.

⁷ Federal Geographic Data Committee, 1997, *Framework Introduction and Guide*, p. 21.

⁸ Delimitation/delimited/delimiting means the determination of a boundary; it includes all phases of boundary development.



Chapter I—Land Descriptions

Purpose

Public land orders, Executive orders, and proclamations containing land descriptions are usually designed to reserve and set apart certain tracts⁹ or areas owned or controlled by the Federal Government for specific uses or purposes or for Indian trust responsibilities. These tracts or areas could be reserved or set apart for military and naval requirements; national forests, parks, and monuments; game and bird refuges; Indian or Alaska Native lands; minerals development; various administrative uses; or classification in aid of proposed legislation. An initial action is ordinarily taken by the bureau or agency exercising administrative control or jurisdiction over the land.¹⁰

A proclamation is normally an announcement by the President of the United States issued to

⁹ The term “tract” by common usage is applied to an expanse of land of no particular size. In modern Federal land surveys, the term is used specifically to mean (a) in a rectangular survey, an expanse of land that lies in more than one section or that cannot be identified in whole as part of a particular section and is described by principal meridian, State, township, range, and tract number and (b) in a metes-and-bounds survey, an expanse of land that for identification purposes is labeled tract and is often described by tract number or letter.

¹⁰ By Public Law 94-579, the Federal Land Policy and Management Act of 1976, as amended (90 Stat. 2743; 43 U.S.C. § 1701 *et seq.*), the Secretary of the Interior is authorized to sign all orders withdrawing or reserving public lands of the United States and all orders revoking or modifying such orders.

carry out the provisions of an Act of Congress. Proclamations are usually of wider public distribution than public land orders and Executive orders, which normally apply to affairs of the Federal Government, have a more limited and particular purpose, and may be of a temporary nature or duration. An example of a Proclamation would be the establishment of a new national monument. It is the practice of the Federal Government to withdraw land by Executive order or public land order to survey, examine, and permanently establish the monument. Subsequent modification of the boundaries of such a reservation may become necessary, and the general practice is to accomplish these purposes by Executive order or public land order. In some cases the authorizing legislation specifies the manner in which the action should be taken.

All proclamations are published in the United States Statutes at Large. Proclamations, Executive orders, and public land orders are published in the *Federal Register* under the provisions of the Acts of July 26, 1935 (49 Stat. 500) and October 22, 1968 (82 Stat. 1274; 44 U.S.C. § 1505).

Authority

The President has the power to reserve or withdraw lands owned or controlled by the United States for public purposes. As stated in 6 Pub. Lands Dec. 317: “The President is vested with general authority in the matter of reserving lands for public uses and land so set apart is not subject to disposal under the public land laws during the existence of such reservation.” Section 2 of the Act of June 8, 1906, (34 Stat. 225; 16 U.S.C. § 431 *et seq.*) authorizes the President of the United States, in his discretion, “to declare by public proclamation historic landmarks, historic and prehistoric structures, and other objects of historic or scientific interest that are situated upon the lands owned or controlled by the Government of the United States as national monuments.”

Section 204 of the Federal Land Policy and Management Act of 1976, Public Law 94-579,

90 Stat. 2743; 43 U.S.C. § 1714, authorizes the Secretary of the Interior (Secretary) to make, modify, extend, or revoke withdrawals in accordance with the provisions and limitations of the section. The Secretary may delegate this withdrawal authority only to individuals in the Office of the Secretary who have been appointed by the President of the United States, by and with the advice and consent of the U.S. Senate.

Descriptions of Land

The land description portion of a land order, proclamation, or any document delimiting limits of land or space must be susceptible to one, and only one, interpretation. Simplicity and clarity are paramount and are to be achieved through established proper usage of terminology, phraseology, punctuation, arrangement, and paragraphing. The land description should furnish sufficient information for the identification of the spatial limits or area by a land surveyor. It should contain clear “intent” and proper “qualification” of the lands being described for the present and the future without ambiguity.

The definition of a legally sufficient real property description is one that can be located on the ground by a land surveyor. R. H. Skelton wrote in *The Legal Elements of Boundaries and Adjacent Boundaries*: “The only rule that can be definitely given for the writing of deed descriptions is—The scrivener should place himself as nearly as possible in the seats which will be occupied by those who, twenty years hence, attempt to lay down the grant—describe the land conveyed with such clarity and certainty that the intention as effectively expressed will be as significant to the next generation as it is to the writer.”

Executive orders have prescribed certain requirements in connection with the preparation of land descriptions. These requirements state that each document will have a suitable title; the citation under which it is issued; proper punctuation, capitalization, spelling, and style; and the correct spelling of geographic names. The

land descriptions of tracts or areas must conform to Bureau of Land Management (BLM) cadastral survey standards, when applicable.

The drafting of public land orders, Executive orders and proclamations is subject to review by a legal expert regarding the correctness of the legal subject matter, as to the citation of the appropriate statutes and previous land orders and proclamations and reference to Federal court decisions. In like manner, equal care should be taken to formulate the land description of a tract or area in plain technical terms and using the nomenclature and scheme of corner identification in accordance with chapter IV of the *Manual of Surveying Instructions* (Survey Manual). Each land description should be written, or at a minimum scrutinized, by a boundary survey expert. This review will consider not only the technical sufficiency and form of the land description but also the feasibility and practicability of the boundary from the viewpoint of proper administration.

The originating bureau or agency is responsible for the authenticity and accuracy of the data upon which the land descriptions are based. Field notes and plats of the basic surveys or copies of deed records or comparable documents, together with maps or diagrams showing the tract, spatial limits, or area to which the description refers should be available for review and reference.

Types of Descriptions

Descriptions of land in land orders and proclamations are of three general types, with many land descriptions combining two or more of these types:

1. Those cases where the lands are described by reference to designated Public Land Survey System (PLSS) subdivisions based upon surveys of official character and shown upon plats filed in the United States survey records (figure 1). The most common of these are aliquot parts of the rectangular system of surveys.

2. Those cases where the location and limits of land are described in specific terms by recital of its boundaries and/or adjoiners, generally termed a metes-and-bounds description.
3. Those cases where the lands are described by reference to designated subdivisions based upon surveys and shown upon plats or maps filed in a public office, generally termed a lot and block survey or residential subdivision survey.

Reference to Official Records

The first type of land description referred to in the preceding paragraph was considered by the United States Supreme Court in the case of *Cragin v. Powell*, 128 U.S. 691, 696 (1888), from which the following is quoted:

It is a well-settled principle that when lands are granted according to an official plat of the survey of such lands, the plat itself, with all its notes, lines, descriptions, and landmarks, becomes as much a part of the grant or deed by which they are conveyed, and controls, so far as limits are concerned, as if such descriptive features were written out upon the face of the deed or the grant itself.

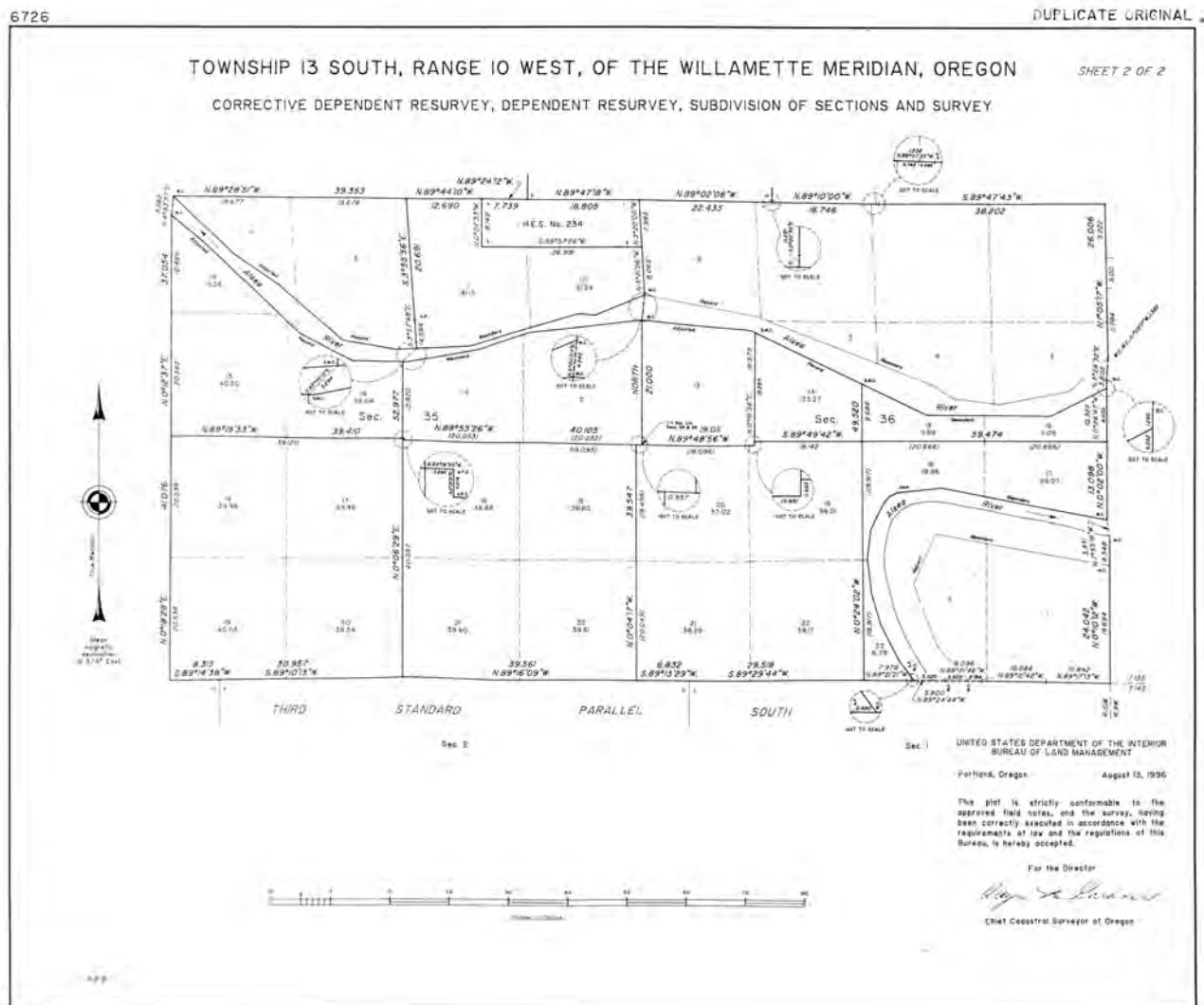

Figure 1. Example of an official plat.

This fundamental principle finds wide application in the description of tracts and areas located both within and outside of the original public domain. Because of the large volume of land orders and proclamations involving lands in the 30 public land states, chapter II is devoted to land descriptions based on the official plats of that system.

However, the principle of reference to a record of survey is generally applicable to all kinds of land descriptions. For example, parcels may be described by lot and block numbers of a city or townsite subdivision based upon a properly identified plat duly recorded in a public office of record.

Descriptions based on recorded plats and maps of the character just referred to by designation of subdivision shown thereon should identify the

particular plat or map by title and date, giving the name and location of the place of record as well as the approving or certifying authority. Such methods will have the advantage of a plat or map being incorporated as part of the description and will show intent. Below is an example of a land description referring to a survey:

It is hereby certified That, the application 1234, filed pursuant to the Act of May 17, 1906, as amended, has been approved pursuant to the act, as amended, for the following described land:

U.S. Survey No. 14188, Alaska.

Containing 80.00 acres, as shown on the plat of survey officially filed on September 30, 2011.



Chapter II—The Public Land Survey System

Rectangular Surveys

On May 20, 1785, the Congress of the Confederation passed “an ordinance for ascertaining the mode of locating and disposing of lands in the western territory and for other purposes therein mentioned.” Shortly thereafter, the part of the Northwest Territory that became the State of Ohio was used to experiment and develop the system of rectangular surveys prior to disposing of the land. This system became known as the Public Land Survey System. Revisions to the rules of survey and disposition were made as the survey and settlement progressed westward. The revisions to the General Plan are codified in the editions of the Survey Manual, published by the Department of the Interior.¹¹

The rectangular system was used in that part of the United States acquired by the Federal Government by cession from the states, treaty, and purchase, now embraced in the public land states of Alabama, Alaska, Arizona, Arkansas, California, Colorado, Florida, Idaho, Illinois, Indiana, Iowa, Kansas, Louisiana, Michigan, Minnesota, Mississippi, Missouri, Montana, Nebraska,

¹¹ The current edition is the *Manual of Surveying Instructions* (2009) at <http://bit.ly/surveymanual2009>.

Nevada, New Mexico, North Dakota, Oklahoma, Ohio, Oregon, South Dakota, Utah, Washington, Wisconsin, and Wyoming, which comprised the original public domain. The rectangular system of surveys has been extended or is now in progress over this area as the basis for the identification, administration, and disposal of the remaining Federal interest lands and is the basis for the identification of the disposed lands.

The land description within the scope of the PLSS rectangular surveys should conform to the accepted nomenclature of that system, citing the name of the proper principal meridian, the state, the appropriate township and range numbers, and where necessary, the section and sectional subdivisions shown upon the official plats of survey.¹² Each principal meridian has its own base line; therefore, the words “and base line” are usually omitted from the meridian. The name of the principal meridian should be spelled in full. If the lands have not been surveyed, the description should conform to the subdivisions shown on the approved protraction diagram. If the lands have not been surveyed and there is no approved protraction diagram, the description should conform to the legal subdivisions that will, when established, include the lands.

A detailed description of the rectangular system of survey and its nomenclature is given in the Survey Manual. Figure 1-1 in the Survey Manual depicts the principal meridians and base lines of the PLSS.

The rectangular survey system is basically curvilinear lines based upon true meridian and is originated from an “initial point.”¹³ Once the initial point is established a north and south line is configured through the point with reference

¹² Most PLSS land descriptions by law are implicitly descriptions by reference, i.e., the area of interest has previously been delimited on an official survey plat. When the Federal Government writes the land description, the presumption is that the intention is in conformance with the PLSS for establishment of survey monuments and the survey record prior to a land description, unless explicitly stated otherwise.

¹³ Lines of constant bearing (rhumb lines), reported as horizontal distance at average ground elevation of the end points. True meridian is defined by the axis of the earth’s rotation. See chapter II of the Survey Manual for a discussion of the Public Land Survey System datum.

to “true north,” not magnetic north. This line is referred to as the “principal meridian” and is extended as far north or south as necessary for the lands to be referenced to this meridian. Next, an east and west line is configured through the initial point parallel to the equator. This line is referred to as the “base line” and is extended east and west as far as necessary for the lands to be referenced to this base line. “Township lines” are then established north and south of the base line at 6-mile intervals and numbered north or south from the base line as necessary. Then “range lines” are established east and west of the principal meridian at 6-mile intervals and numbered east or west of the principal meridian as necessary. The intersection created by the township lines and the range lines form a nominal 6-mile square creating what is referred to as a “township.”

Two different meanings have been applied to the term “township.” The first use of the term “township” is to describe a series of nominal 6-mile-wide horizontal rows north and south of the base line. The second use of the term “township” is to describe the nominal 6-mile-square area that is situated between two adjacent range lines and two adjacent township lines. By the General Plan, this 6-mile-square township is the unit of survey. Each township is subdivided into 36 “sections,” with each section being nominally 1 mile square, 640 acres, and numbered from 1 to 36, according to the plan shown in figure 2. The section lines are normally surveyed from south to north and from east to west, with any excess or deficiency placed against the north and west boundaries of the townships.

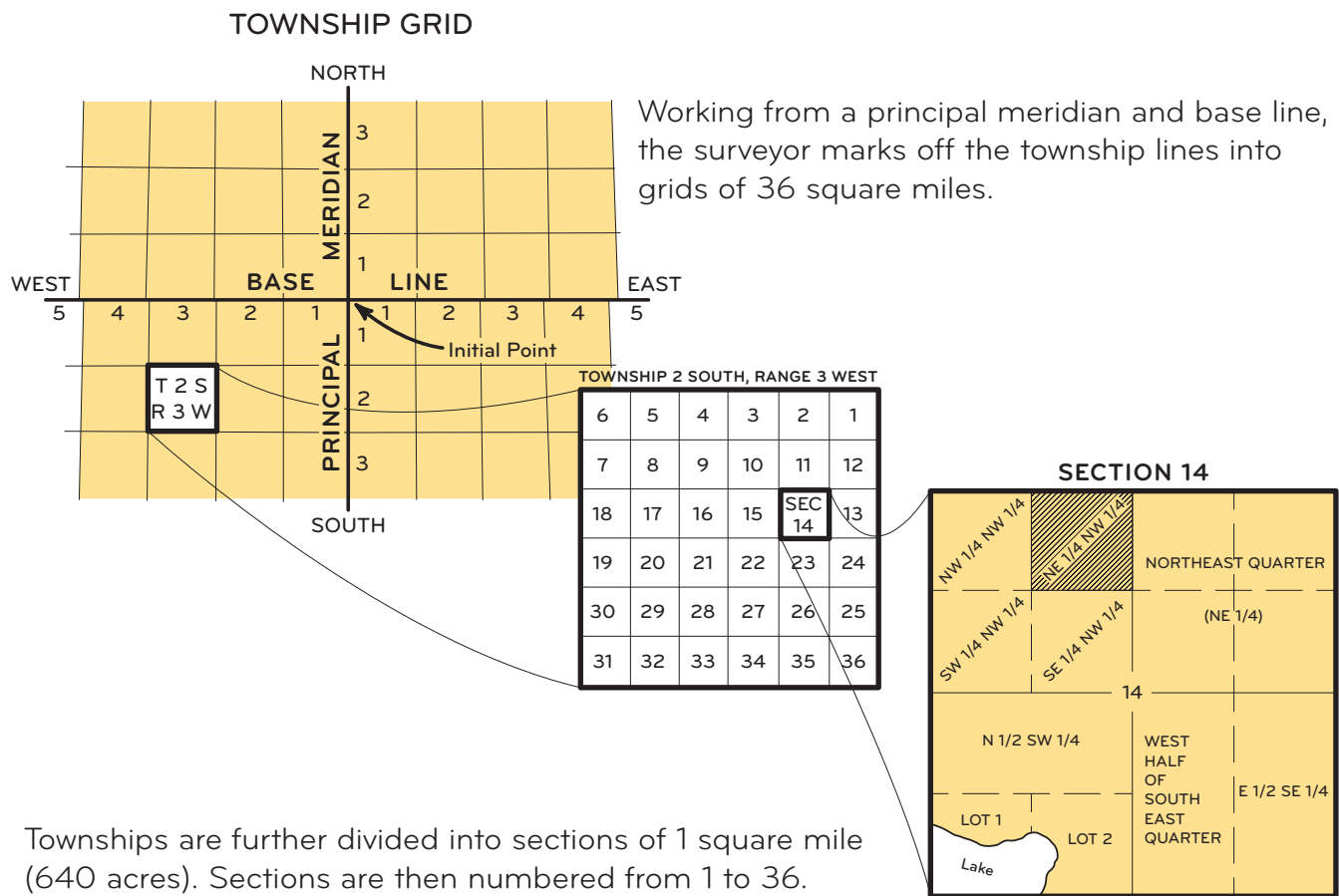

Figure 2. Example of township and range lines for the establishment of townships, section lines for the establishment of sections, and subdivision of section lines for the establishment of aliquot parts and lots of a section.

Under the general land laws, the unit of administration is the quarter-quarter section of nominally 40 acres or the lot, either of which is often referred to as the smallest legal subdivision. Under mining and reclamation laws, the smallest legal subdivision is the quarter-quarter-quarter section of 10 acres. Some special statutes specified even smaller legal subdivisions.

By the General Plan, the section is subdivided into units of administration, called legal subdivisions. These are of two types, aliquot parts and lots.¹⁴ The section is subdivided into quarter-sections by running straight¹⁵ lines from the established quarter-section corners to the opposite corresponding quarter-section corners. These nominal 160-acre units are designated by symbol in tabular descriptions as NE1/4, NW1/4, SW1/4, and SE1/4.

The quarter-section is subdivided into quarter-quarter sections by running straight lines from the established quarter-quarter section corners to the opposite corresponding quarter-quarter section corners. These nominal 40-acre units are designated by symbol in tabular descriptions as, for example, SW1/4NE1/4. Occasionally the quarter-quarter section is further subdivided into its aliquot parts by connecting opposite corresponding corners. These resulting nominal 10-acre units are designated by symbol as, for example, NW1/4SW1/4NE1/4.

¹⁴ For definitions of terms related to describing PLSS aliquot lands and lots, see the *Glossaries of BLM Surveying and Mapping Terms* publication, which includes the following:

ALIQUOT – A process of dividing an area such that the results contain an exact number of times in another; a part of a measurement that divides the measurement without a remainder. Divisions based on the mid-points of linear measurement of the opposing lines and the intersection of the lines connecting these mid-points.

ALIQUOT PART – An area that is a legal subdivision of a section by division into halves or fourths *ad infinitum*; except lots.

LOT – A legal subdivision of a section that is not described as an aliquot part; without aliquot characteristics; the lot is generally designated by a numerical value, e.g., lot 2. The term “government lot” is commonly used by persons in the non-Federal sector in referring to such a legal subdivision of a section. “Lot” is also the name given individual parcels of recorded subdivision of private tracts, i.e., lot and block subdivisions.

¹⁵ By statute, in the PLSS datum, the term “straight line” is used when describing a line of constant bearing.

In theory, aliquot parts can be divided *ad infinitum*. However, the lengthy descriptions that result from this practice tend to invite error in the preparation and recordation of documents. Such lengthy descriptions also further complicate the maintenance and interpretation of the land records. As a policy (Survey Manual sections 3-33 and 9-90), land descriptions by aliquot part must not go beyond a four component description. For example, a 5-acre unit described as the S1/2NE1/4NW1/4SE1/4 is acceptable, as is a 2½-acre¹⁶ unit described as the SE1/4NE1/4NE1/4SW1/4. Aliquot parts of 1¼-acre or less described with five components or more, e.g., W1/2SE1/4NE1/4SW1/4SE1/4, are unacceptable. When subdivision of lands into aliquot parts of less than 2½-acres is anticipated, an official survey will be conducted or a supplemental plat will be prepared and lot numbers assigned. Exceptions may be granted in cases where the actual on-the-ground location of the division line does not and will not govern. If the originating bureau or office determines there is a need for an exception, requesting a Standards for Boundary Evidence Certificate(s) (SBE) from a Certified Department of the Interior Land Surveyor (CILS)¹⁷ is advised.

Preferred Order

If more than one township is included, the preferred numerical order of listing is to begin with the lowest range number, and within each range by the township numbers, also beginning with the lowest. Where townships east and west of the principal meridian or north and south of the base line or both are involved, the preferred order of listing is first those north and east of the initial point, followed by those north and west, south and west, and south and east in the order named. All the parts of each township and range will be

¹⁶ Some word processing software may automatically replace certain full-sized fractions (1/2) with single-character fraction symbols (½). These symbols are acceptable when describing numerical measurements, e.g., 2½ acre unit, but full-sized fractions should be used in land descriptions, e.g., SE1/4NE1/4SW1/4SE1/4.

¹⁷ See Department of the Interior Departmental Manual “Standards for Federal Lands Boundary Evidence” (600 DM 5).

described before proceeding to the next township and range.

The preferred order of listing sections is to begin with the lowest-numbered section in each township, giving first the lot numbers in order, then the subdivisions within each quarter section, in the order NE, then NW, SW, and SE; if parts of the quarter-sections are to be described, the same order is observed, and all the parts of each quarter-section will be described before proceeding to the next quarter-section and so on. Tracts should follow the sections because a tract is part of a township, as is a section, and is numbered the same as a section, beginning with 37 or the next highest unused numerical designation to avoid confusion with section numbers. Tracts should be listed before nonrectangular surveys, e.g., mineral surveys, donation land claims.

Preferred Method for Writing Descriptions

A proper aliquot part description should contain all of the reference elements within it: principal meridian, State, township and range, section, and lots or aliquot parts.

Example: Assume it is section 15, township 4 north, range 20 east,¹⁸ Mount Diablo Meridian, Nevada. The proper aliquot description should contain all of the reference elements within it:

Mount Diablo Meridian, Nevada
T. 4 N., R. 20 E.,
sec. 15, NW1/4, NE1/4SE1/4SW1/4,
and NW1/4SE1/4.
The area described contains 210 acres.

The use of a comma is significant in writing the descriptions of the subdivisions of a section. A comma means “AND THE” and the absence of a

comma means “OF THE.” The improper use or placement of a comma could drastically change an aliquot description and the intended acreage to be described. The description NE1/4SW1/4SE1/4 without a comma describes an aliquot part of 10 acres. With a comma, as such NE1/4, SW1/4, SE1/4 describes three aliquot parts totaling 480 acres. The proper use of the comma in an aliquot description is as follows: The NW1/4, NE1/4SE1/4SW1/4, and NW1/4SE1/4, describes three aliquot parts containing 210 acres.

In using symbols, the usual punctuation is omitted in the aliquot part description. The period is omitted after N, NE, S, SE, etc., within the aliquot parts description, and that there is no comma and no space between symbols indicating a quarter-quarter section (NE1/4SE1/4). The usual punctuation is included in the portion of the land description where township and range are abbreviated (T. 4 N., R. 20 E.).

Some contiguous units may be combined. For example, if section 10, NW1/4 and section 10, SW1/4 are included, the resulting 320-acre unit can be designated as “sec. 10, W1/2.” Where section 22, NE1/4NW1/4 and SE1/4NW1/4 are included, the resulting 80-acre unit can be designated as “sec. 22, E1/2NW1/4.” And where section 22, NE1/4NW1/4, NW1/4NW1/4, and SE1/4NW1/4 are included, the unit can be designated as “sec. 22, N1/2NW1/4 and SE1/4NW1/4.” The combination will follow the preferred order of listing. When the entire section is included, whether containing lots or not, the whole section can be designated (sec. 6).

One half of a regular section consists of two quarter-sections having a common boundary, and the section is divided by a line between opposite quarter-section corners. Half of a half description should not be used as it could cause ambiguity to the intended location of the division

¹⁸ Within the rectangular survey system, when used in text, the terms parcel, tract, lot, section, township, and range should be lowercase.

line.¹⁹ For example if section 10, W1/2NW1/4 and W1/2SW1/4 are included, the symbol “sec. 10, W1/2W1/2” is not used. The latter description is ambiguous and subject to more than one interpretation.

For half of a half description of acquired lands, the prevailing rule does vary from State to State as to whether the presumption is to describe half by area or half by government measurement. Half of half descriptions should not be used or used only with extreme caution, and if there is doubt as to the location of the division line, further explanation of the intent is required.²⁰

The sections along the north tier and west range of a regular township are typically irregular sections and contain lots. These lots are a legal subdivision of a section and designated by section and lot numbers such as “sec. 3, lot 1.” Lots cannot be

¹⁹ HALF – A part of a section subdivision (section, quarter-section, quarter-quarter section, quarter-quarter-quarter section, etc.), by government measurement, is determined according to equally divided or at proportionate linear measurement of opposing lines without consideration of the areas of the halves. This is the rule unless a contrary intent is explicitly shown. See *Glossaries of BLM Surveying and Mapping Terms*.

(1) How to subdivide quarter-sections is defined by Federal statute law;

(A) 43 U.S.C. § 752 (Act of February 11, 1805; 2 Stat. 313):

“The boundaries and contents of the several sections, half-sections, and quarter-sections of the public lands shall be ascertained in conformity with the following principles:”

First. “. . . and the corners of half- and quarter-sections, not marked on the surveys, shall be placed as nearly as possible equidistant from two corners which stand on the same line.”

Second. “And the boundary lines which have not been actually run and marked shall be ascertained, by running straight lines from the established corners to the opposite corresponding corners;”

(B) 43 U.S.C. § 753 (Act of April 24, 1820; 3 Stat. 566, and Act of April 5, 1832; 4 Stat. 503): Describes that the division and content of a quarter-section and of a half quarter-section shall be ascertained in the manner and on the principles directed and prescribed by 43 U.S.C. § 752. That is, a quarter-section is divided by a straight line connecting the opposite corresponding quarter-quarter (1/16) section corners. To subdivide the NE and NW quarter sections into halves, the center 1/16 section corner must be established. Running a straight line from one exterior 1/16 section corner to the opposite exterior 1/16 section corner will not intersect the center 1/16 section corner, except in very rare cases.

²⁰ In the rare instance where half (1/2) of a half (1/2) is used in a land description, a statement at the end of the description, after the area statement, similar to “Any area described as a half (1/2) of a half (1/2) is based on the proper subdivision of section in accordance with the *Manual of Surveying Instructions*” will be included.

described as aliquot.²¹ For example, an irregular section 3 will normally contain four lots adjoining the north boundary of the township. A contiguous unit, such as lots 1 and 2, and S1/2NE1/4 should not be combined as NE1/4. The latter description is ambiguous and subject to more than one interpretation. See figure 3 for other situations for lots within irregular sections. When a whole section containing lots is to be described, just the section number should be cited.

Lots have been erroneously patented in halves or quarters. Without explicit evidence of the Federal Government’s intent, the location of the division line is uncertain. For example, is the division line to be determined by a straight line between equally divided opposing lines, or at proportionate linear measurement of opposing lines, or with regard to equal areas? If the latter, it is still a question of how the equal areas are to be achieved, i.e., whether the division line to be determined is parallel with the opposing boundary or run to form a parallelogram, etc.

Lots and other irregular tracts/parcels do not have aliquot characteristics. When they are subdivided there is a remainder. The uncertainty of the location of the remainder intended by the subdivision renders the description ambiguous and subject to more than one interpretation. When subdividing lots or tracts, an official survey will be conducted or a supplemental plat will be prepared with lot numbers assigned to each subdivision to clearly show the intent.



²¹ See footnote 14.

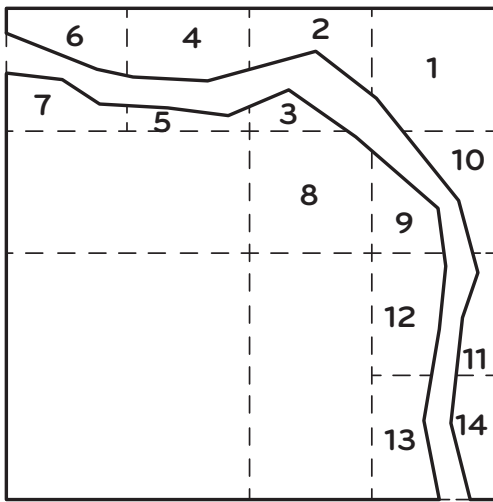

Meanderable River.

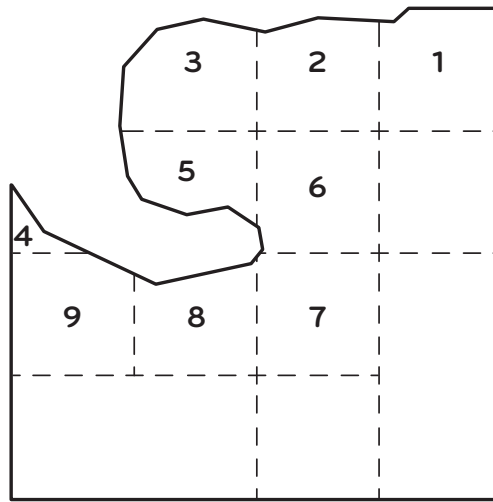

Meanderable Lake.

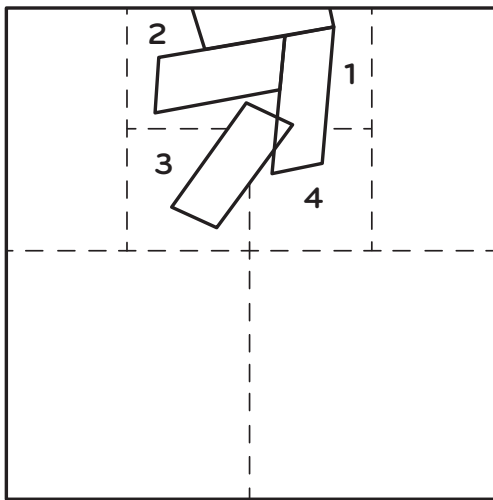

Mineral Claims.

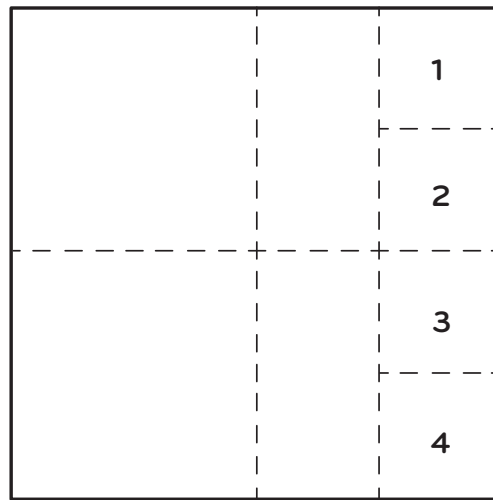

E. bdy. defective in alinement.

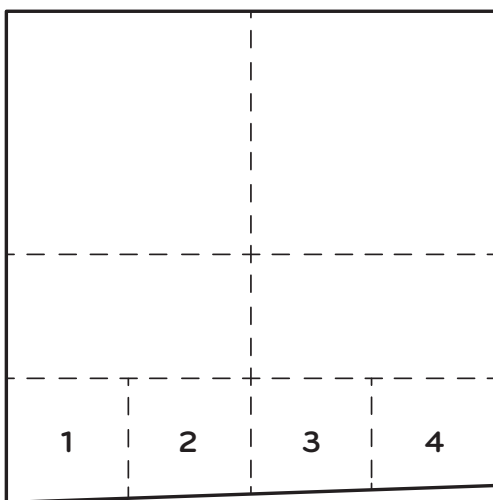

S. bdy. defective in alinement.

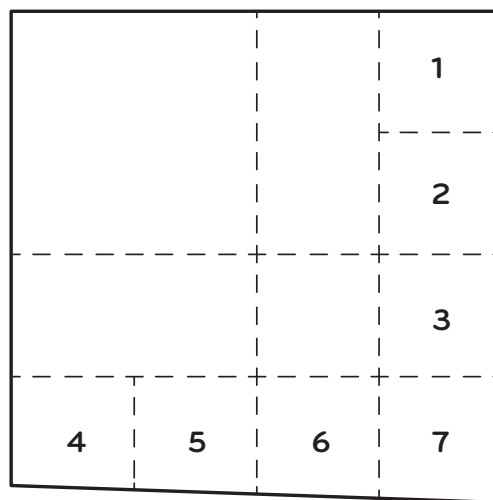

E. & S. bdrs. defective in alinement.

Figure 3. Examples of subdivision of sections by protraction and showing lots.

Area

In some cases, a statement of the total area follows the description. If the lands described are entirely surveyed, the legal (nominal) acreage as shown upon the official plats of survey will be used. Where unsurveyed²² land is included, the acreage as shown upon the official protraction diagrams of the township will be used. Where land is not returned on an official survey plat and there is no official protraction diagram, an approximate area will be given in even acres.

The terms “land” and “area” are used when referring to delimited land or area that has contiguity.²³ The terms “lands” and “areas” are used when referring to delimited lands or areas that do not have contiguity.

When referencing the acreage for land or area having contiguity, the following statement will be used: The area described contains _____ acres.

When referencing the acreage for lands or areas not having contiguity, the following statement will be used: The areas described aggregate _____ acres.

Where both Federal and non-Federal interest lands are included, the following statement will be used: The areas described, including both Federal and non-Federal lands, aggregate _____ acres.

Descriptions containing the legal acreage as shown upon the official plats of survey will carry a statement as follows: The area (or areas) described contains (or aggregate) _____ acres, according to the official plat (or plats) of the survey (or surveys) of the said land (or lands), on file with the BLM.

Where a section contains one or more lots, its aliquot parts show the usual areas as 40, 80, or 160 acres; the lots each show the assigned lot

²² In the Federal survey system, unsurveyed means not returned (described) on an official survey plat.

²³ Contiguity means where delimited lines of land or area touch. Lands or areas that touch only at a corner are not contiguous.

number and are shown to the nearest 0.01 acre. Where aliquot parts are according to the official plat of survey of the said land, the words “more or less” are not used. Delimited areas having a rounded acreage of less than 0.01 acre should be shown as having 0.01 acre. The square footage of a delimited area justified by the accuracy of the survey may be shown as an additional exhibit.

When acreage other than the legal acreage according to the official plat of survey of the said land is used, the source for the acreage and an explanation of its derivation should be included in the documents to be reviewed. A great deal of confusion is needlessly interjected into the management of special areas when acreage either is derived from unofficial sources or is based upon erroneous assumptions.²⁴

It is not expected that every bureau or office will have the mathematical necessities to provide official or accurate acreage. To determine or confirm the status of the acreage it is advisable to request a SBE Certificate(s) from a CILS.

²⁴ For a discussion of the Public Land Survey System Datum and associated area computations, see chapter II of the *Manual of Surveying Instructions*.

Using plane computational techniques within the PLSS will create problems due to the orthogonal nature of basic trigonometric functions. Geodetic computations or the use of geodetic projections will eliminate many problems. To properly use these projections, many factors must be addressed, such as proper conversion to and from the true meridian, to and from mean bearings, and between ground horizontal distances and grid distances. To properly use geodetic computations, the correction between mean, forward and back bearings, and the elevation of the lines must be considered.

The mathematical conversions between field measurements and plane coordinate values involve many relationships. Some of the considerations to be treated correctly before accurate acreage can be assured are: Sea level factors relate ground distances to sea level or geoid equivalents. Elevation factors relate ground distances to geodetic equivalents on the ellipsoid. Grid scale factors relate ellipsoidal or geodetic distances to an equivalent on the projection or grid surface. The mapping angle, or convergence angle, relates geodetic north to grid north. Arc to chord, or second-term corrections, relate observed pointings to equivalents on the grid and are relevant to both bearings and angles. The grid bearing is a true bearing only along the central meridian of a given State Plane Coordinate System zone, and a grid distance is not generally a true ground distance.

Many popular commercial computing software applications do not compute PLSS areas accurately. For example, when the software is written for plane coordinate computations, the acreages computed can be significantly different from acreage derived from geodetic coordinate computations based upon PLSS constraints. Acreage on the grid surface differs from the sea level surface, and both differ from the ground surface used in the PLSS.

Table 1. Conversions used in PLSS surveying.

Units of Linear Measure

1 chain	=	100 links
	=	66 feet (U.S. Survey Foot)
	=	4 poles, perches, rods
1 mile	=	80 chains
	=	5,280 feet (U.S. Survey Foot)

Units of Area

1 acre	=	10 square chains
	=	43,560 square feet (U.S. Survey Foot)
1 square mile	=	640 acres

Metric Conversions

<i>U.S. Survey Foot</i>		
1 meter	=	39.37 inches (exact)
1 U.S. Survey Foot	=	0.3048006096... meter
1 link	=	0.2011684023... meter
1 meter	=	3.2808333333... U.S. Survey Foot
1 acre	=	0.40468726099... hectare

International Foot (SI)

1 inch	=	25.4 millimeters (exact)
1 SI foot	=	0.3048 meter (exact)
1 meter	=	3.2808398950... SI Foot

Conventional Symbols and Abbreviations

The conventional symbols for degrees (°), minutes ('), and seconds (") of arc should usually be employed in giving the direction of lines.

The abbreviations for the units most frequently used are:

Chains(s)ch., chs.
Link(s)lk, lks.

Foot (feet)ft.
Meter(s)m.

The words “township” and “range” and the designations “north” or “south” and “east” or “west” are sometimes written in full when used in the text, but the land description itself should be in tabular form, and these terms should be abbreviated and capitalized where appropriate. The principal abbreviations are as follows:

Township(s)T. or Tps.
Range(s)R. or Rs.
Section(s)sec. or secs.
NorthN.
NortheastNE

Where two or more township units are to be grouped in the description, the plural abbreviation “Tps.” and/or “Rs.” should always be used, even though all the townships have the same number east or west of the principal meridian or north or south of the base line. The term “township” and “range” is abbreviated in the singular or plural as the meaning may require, for example:

T. 13 N., R. 11 E.	(1 township)
Tps. 4 and 5 N., R. 14 W.	(2 townships)
Tps. 3 S., Rs. 16 and 17 W.	(2 townships)
Tps. 1 thru 4 S., Rs. 6 thru 9 E.	(16 townships)

Examples of Descriptions of Lands Based upon the Rectangular Surveys of the Public Land Survey System

Single Section Example No. 1

Fourth Principal Meridian, Illinois
T. 28 N., R. 8 E.,
sec. 9, SE1/4.
The area described contains 160 acres.

Multiple Sections Example No. 2

Fifth Principal Meridian, North Dakota
T. 160 N., R. 66 W.,
sec. 6, lots 4 thru 7,²⁵ SE1/4NW1/4, and E1/2SW1/4;
sec. 7, lots 1 thru 4, E1/2NW1/4, and E1/2SW1/4;
sec. 17, W1/2SW1/4;
sec. 18, NE1/4;
sec. 20, W1/2NW1/4 and SW1/4.
The areas described aggregate 1,090.18 acres.

Multiple Sections and Townships Example No. 3

Black Hills Meridian, South Dakota
T. 3 S., R. 1 E.,
sec. 6;
sec. 8, SE1/4;
sec. 21;
sec. 28, E1/2, N1/2NW1/4, SE1/4NW1/4, and NE1/4SW1/4;
sec. 31, lots 2 and 4, NW1/4NE1/4, NE1/4NW1/4, and SE1/4;
sec. 34, W1/2NE1/4, W1/2, W1/2SE1/4, and W1/2SE1/4SE1/4.
T. 5 S., R. 2 E.,
sec. 17, N1/2, excepting SDM 43307;
sec. 22, N1/2, reserving SDM 43308;
sec. 34, N1/2, subject to SDM 43309.
T. 5 S., R. 3 E.
T. 6 S., R. 3 E.,
sec. 4, lots 1, 2, 3, 7, and 8, SW1/4NE1/4, S1/2NW1/4, and SE1/4;
secs. 15, 17, and 18.
The areas described, including both Federal and non-Federal lands, aggregate 28,184.79 acres.

²⁵ It is stipulated that the word "thru" implies inclusive, i.e., lots 4, 5, 6, and 7.

Example No. 4

Salt Lake Meridian, Utah

T. 39 S., R. 10 W.,

sec. 31, lots 4 thru 14 and lots 19 thru 30.

T. 40 S., R. 10 1/2 W.,

sec. 1, that portion lying southerly of the southerly right-of-way boundary of UTU 43433;

sec. 2, unsurveyed.

T. 38 S., R. 11 W.,

secs. 31, 32, and 33, those portions lying northerly and easterly of the centerline of U.S. Highway 93.

T. 39 S., R. 11 W.,

secs. 4 thru 9 and secs. 16 thru 21, partly unsurveyed;

sec. 24, NE1/4 and S1/2;

secs. 25 thru 29 and secs. 33 thru 36.

T. 40 S., R. 11 W.,

secs. 2, 3, 4, 9, 10, 15, 16, 21, 22, 27, 28, 33, and 34.

T. 41 S., R. 11 W.,

sec. 4;

sec. 5, lots 1 and 2, S1/2NE1/4, and SE1/4;

sec. 8, NE1/4;

secs. 9, 16, and 21.

T. 38 S., R. 12 W.,

sec. 10, N1/2 and SW1/4;

sec. 11, W1/2 and SE1/4;

sec. 12, N1/2 and SE1/4;

sec. 13, NE1/4 and S1/2;

sec. 21, E1/2;

secs. 22, 23, and 24;

sec. 29, lot 1 and lots 3 thru 8;

secs. 33 thru 36.

T. 39 S., R. 12 W.,

secs. 1 thru 4 and secs. 9 thru 15, partly unsurveyed;

sec. 16, E1/2;

secs. 22, 23, and 24, partly unsurveyed.

Example No. 5

Mount Diablo Meridian, California

T. 45 N., R. 21 E.,

secs. 1, 2, 4, 6, and secs. 8 thru 17.

T. 46 N., R. 21 E.,

secs. 20 thru 29;

sec. 30, E1/2NE1/4 and E1/2SE1/4;

sec. 31, W1/2NW1/4SE1/4 and W1/2SW1/4SE1/4;

secs. 32 thru 36.

T. 46 N., R. 22 E.,

secs. 4 thru 9, secs. 11 thru 14, and secs. 16 thru 21, partly unsurveyed.

T. 45 N., R. 23 E.,
sec. 8, W1/2SE1/4;
sec. 10, N1/2NE1/4 and SW1/4NE1/4;
sec. 11, W1/2NW1/4 and SE1/4NW1/4;
sec. 12, N1/2SW1/4 and SE1/4SW1/4;
sec. 13, NE1/4SE1/4 and S1/2SE1/4;
sec. 20, W1/2NE1/4, unsurveyed;
sec. 28, W1/2SW1/4;
secs. 29 thru 32.

Example No. 6

Principal Meridian, Montana

Tps. 1, 2, and 3 N., R. 1 E., unsurveyed.

Tps. 1 thru 4 N., Rs. 2 and 3 W., partly unsurveyed.

T. 1 S., R. 18 W.,
secs. 1 thru 18.

Tps. 1 S., Rs. 19 and 20 W., partly unsurveyed.

T. 1 S., R. 19 E.,
sec. 33, lots 1, 2, and 4, and lots 6 thru 9;
sec. 34, that part lying northwesterly of the medial line, an ambulatory line, of Snake Creek;
tracts 43, 44, 46, and tracts 48 thru 53.

Example No. 7

Sixth Principal Meridian, Wyoming

T. 37 N., R. 67 W.,
secs. 4 thru 9, secs. 16 thru 21, and secs. 28 thru 33.

T. 38 N., R. 67 W.,
secs. 4 thru 9, secs. 16 thru 21, and secs. 28 thru 33.

T. 39 N., R. 67 W.,
secs. 1 thru 24 and secs. 28 thru 33.

Tps. 40, 41, and 42 N., R. 67 W.

Tps. 37 thru 40 N., R. 68 W.

Tps. 38 N., Rs. 69, 70, and 71 W.

Tps. 39 N., Rs. 70 thru 73 W.

T. 44 N., R. 70 W.,
secs. 1, 2, and 3, secs. 10 thru 13, secs. 22 thru 27, and secs. 34, 35, and 36.

Example No. 8

Gila and Salt River Meridian, Arizona

T. 23 N., R. 32 W.,

sec. 4;

tract 37.

T. 23 N., R. 33 W.,

sec. 9;

tract 46;

M.S. No. 3202.

Tps. 23 N., Rs. 34 and 35 W.,

tract 57;

M.S. No. 246.

The areas described aggregate 3,233.86 acres.





Chapter III—Metes-and-Bounds Surveys

The land description by this method should be prepared from surveyed information (map, plat, or notes of the survey) or record information that has been verified, is locatable on the ground, and can be written without ambiguity.

Metes-and-bounds descriptions are used to describe the boundaries of parcels that involve unusual applications of or departures from the rectangular system of the PLSS. In the PLSS, there are many special surveys of nonrectangular parcels, including mineral lode claims, forest homestead entries, private claims, small holding claims, ranchos, U.S. surveys, donation land claims, reservations, and congressionally designated areas. Almost all will be a description by reference, e.g., to U.S. Survey No. 12345. All metes-and-bounds land descriptions published in the *Federal Register* either should be copied from official records, written by a land surveyor, or referred to a land surveyor for review of the accuracy and sufficiency of the description.

A monument may consist of an object or mark that serves to identify the location of a line constituting a part of the boundary; it may be either natural,

such as a river, lake, rock ledge, tree, or ridge, or artificial, such as a wall, fence, ditch, road, marked stone, or post.

The location and the delimiters of land or marine area(s) may be defined by describing its boundaries; by naming natural or artificial monuments to, from, or along which it runs; by stating the lengths and directions of the lines connecting successive corners and/or monuments; or by giving the boundaries of abutting lands or marine areas.

If the lines of adjoining land or marine area(s) form a common boundary with the land or area in question, the description should note this fact, identifying the adjoining land or area by the name of the owner, survey designation, description designation, or other appropriate means.

Natural and Artificial Boundaries

The controlling elements within a description have importance and hierarchy in their use. It is important that the scrivener of a land description is as familiar with these as the retracing land surveyor. If the scrivener understands the controlling elements and their order of importance, he or she should be able to prepare the land description with clear intent and minimal or no ambiguity. In law, the hierarchy of calls is often called “rules of construction.” Detailed discussion of controlling elements, their order of importance, and examples of their application are beyond the scope of this publication.

Occasionally the boundaries of land are defined entirely or in part by natural monuments, such as inland waters, divides, or straight lines connecting prominent features of topography. In such cases, each boundary should be described so definitely and specifically that there is no uncertainty as to its location by identification of features.

Descriptions referring to an inland stream or river can be susceptible to more than one interpretation, and it is imperative that the intent be stated with particularity. In navigable waters, the ordinary high water mark, the deepest navigable channel

(thalweg), or a medial line is usually specified. In meandered nonnavigable waters, the ordinary high water mark, the medial line, or the deepest channel (thread) is specified. And in nonmeandered nonnavigable waters, the medial line or the deepest channel (thread) is usually specified. In the case of tidal waters, the line of mean high tide is usually specified.

In referring to a natural monument such as a divide or peak, or to such permanent artificial monuments as ditches or stone walls, the specific line or point intended to be used should be described with sufficient particularity as to be capable of definite identification and susceptible to only one interpretation. Boundaries of this sort are normally winding, and they may be technically defined by the location of the feature and not by the straight lines between angle points. The intent should be clear in these cases whether the boundary is defined by straight (mean bearing) lines between angle points or by the meander of the feature.

Similarly, in referring to such permanent artificial monuments such as highways, railroads, or utility lines, the specific line must be described with sufficient particularity as to be capable of definite identification and susceptible to only one interpretation. The description should specify whether a right-of-way line, center line, or another location is intended. Also, over time, roadways and utility lines can move via official actions or unofficial activity; typically, the location on the date of the description will be considered the best available evidence of the party's intent.

In connection with these types of boundaries, the agency preparing the land description must consider not only the technical sufficiency and form of the description but the feasibility and practicability of the boundary from the viewpoint of proper administration. For example, the selection of a boundary described as an elevation contour or as paralleling a road at a distance of 2 miles should be avoided as such lines would be difficult to establish, sufficiently ambiguous to require evidence aliunde, and impractical from an administrative standpoint.

By Executive Order No. 11988 of May 24, 1977, entitled *Floodplain Management*, as amended by Executive Order No. 12148 of July 20, 1979, special areas, such as floodplain locations, must be described. In some cases, it may be feasible to describe the lands subject to the restrictive covenant by aliquot parts or by metes-and-bounds. In other cases, the Department of Housing and Urban Development (HUD) floodplain map or a more detailed map of an area may be used. If neither is available, use of the best available information is referenced in the description. The agency should subject proposed descriptions to review by persons experienced in on-the-ground determinations.

Area

A statement of the delimited land or area usually follows the description and, in most cases, is expressed in acres. Where justified by the accuracy of the survey, the value may be carried to the nearest hundredth of an acre or be expressed by square footage. Approximate areas should be indicated as such and given to the nearest full acre.

The Parts of Metes-and-Bounds Descriptions

There are three primary parts of a metes-and-bounds description:

- Caption or preamble
- Body
- Clauses

Caption or Preamble

The caption or preamble provides a general location of the lands to be described, such as city, county, and state. The description could include the section, township, and range; principal meridian; county and state; or subdivision or map reference with the city, county, and state. It may be a combination of any of these. The caption or preamble is used to locate the general vicinity of the land being described. The details of the location of the lands being described are contained within the body of the description.

Caption Example

(see figure 4)

A parcel of land situated in the northeast quarter (NE1/4) of the northeast quarter (NE1/4) of section 21, township 35 north, range 27 west, Fourth Principal Meridian, Sherburne County, Minnesota, being a portion of that parcel of land described in Document No. 4311, filed January 1, 1956, in the official records of Sherburne County and shown in Exhibit “A” and being more particularly described as follows:

Body

The body of a description contains all the specifics for locating the land or space it delineates. The body is a combination of all or portions of the following elements used to describe the land and to reference its location to the surrounding lands:

- Point of commencement
- Point of beginning
- Course (bearing or direction)
- Distance
- Calls by reference

- Calls for monuments and bounds or adjoining lands with qualifying terms and descriptions
- Closing call to the point of beginning or other known locatable point or line
- Area of land contained (if applicable)
- Basis of bearings
- Any additional information that can assist with the accurate location of the land being described (such as clauses)

Abbreviations should be avoided whenever possible.

Body Example

(see figure 4)

COMMENCING at the corner of sections 15, 16, 21, and 22, marked with a 3 inch diameter iron pipe with cap marked R.L.S. 910, identical with the southeast corner described in Document No. 1314, filed March 01, 1923, the southwest corner described in Document No. 1516, filed April 01, 1920, and the northwest corner described in Document No. 1718, filed May 03, 1918, all in the official records of Sherburne County, Minnesota;

THENCE, South 00° 16' 00" West, on the line between sections 21 and 22, identical with the west line of the aforesaid parcel described in Document No. 1718, a distance of 867.90 feet to the center line of a 66 foot wide road parcel described in Document No. 652, filed February 01, 1906, marked with a 1/2 inch diameter iron pipe and the POINT OF BEGINNING of the herein described parcel;

THENCE, South 00° 16' 00" West, continuing on the section line, a distance of 450.78 feet to the north 1/16 section corner of sections 21 and 22, marked with a 3 inch diameter iron pipe with cap marked R.L.S. 1516, identical with the southwest corner described in aforesaid Document No. 1718, the northwest corner described in Document No. 1920, filed June 06, 1913, and the northeast corner described in Document No. 2122, filed July 04, 1921, all in the official records of Sherburne County, Minnesota;

THENCE, South 89° 54' 41" West, on the east and west center line of the northeast 1/4 of section 21, identical with the north line described in aforesaid Document No. 2122, a distance of 1325.26 feet to

the northeast 1/16 section corner of section 21, marked with a 3 inch diameter iron pipe with cap marked R.L.S. 1516, identical with the northwest corner described in aforesaid Document No. 2122, the northeast corner described in Document No. 2324, filed September 12, 1930, and the southwest corner described in Document No. 2526, filed November 11, 1934, all in the official records of Sherburne County, Minnesota;

THENCE, North 00° 12' 00" East, on the north and south center line of the northeast 1/4 of section 21, identical with the east line described in said Document No. 2526, a distance of 823.02 feet to the center line of the aforesaid 66 foot wide road parcel described in Document No. 652, marked with a 1/2 inch diameter iron pipe;

THENCE, along the center line of said road parcel and crossing a portion of the aforesaid described parcel in Document No. 4311, filed January 1, 1956, the following four (4) courses and distances:

1. South 78° 48' 00" East, a distance of 462.00 feet to a 1/2 inch diameter iron pipe for a point of curvature to the right, concave southwesterly,
2. With said curve through a central angle of 42° 57' 00", having a radius of 419.43 feet, an arc distance of 314.42 feet to a 1/2 inch diameter iron pipe,
3. South 35° 51' 00" East, a distance of 327.16 feet to a 1/2 inch diameter iron pipe,
4. North 70° 20' 02" East, a distance of 447.26 feet to a 1/2 inch diameter iron pipe being the **POINT OF BEGINNING**, containing 17.64 acres of land.

BASIS OF BEARINGS: South 00° 16' 00" West, being the north 1/2 of the north 1/2 of the line between sections 21 and 22, by solar observation, referenced to the true meridian.

Clauses

Clauses are usually at the end of the body of a land description and are for the purpose of clarifying, encumbering, taking away from, adding to, or restricting something with reference to the land being described.

A clarifying clause can clearly define the intent of the party(s). For example, when a land description has been updated by survey:

Meaning and intending to convey a portion of the land acquired by the grantor from Dom Smith as shown on Lincoln County Record of Survey No. 9437.

A qualifying clause can imply an encumbrance such as an easement, or a reservation for some use, or a restriction of how the land described may or may not be used, or a reversionary interest. A qualifying clause may also be “*subject to*” any previous recorded encumbrances such as,

easements, reservations, restrictions, or reversions on the land being described.

An augmenting clause can imply the addition of some right or privilege with the property being described such as an access easement, restrictions on adjacent properties for view purposes, or utility easements that are attached to the land described.

Except means excluding from the area or cutting off a portion of the whole area that has just been described, or withdrawals from the description of the property conveyed. *Reserving* means keeping a certain right from the area just granted or taking back a part of something granted. *Subject to* refers to a reservation already existing; when used in a conveyance, it means “subordinate to,” “subservient to,” “limited by,” or “charged to.”

When *exception* and *reservation* are used together, the customary meaning holds that certain property is both withdrawn from the description of what is conveyed and/or an independent right

to an interest in the land is created and vested in the grantor. In the context of split estates, a provision *excepting and reserving* the mineral estate retains and creates title to the mineral estate in the grantor.

External evidence may prove that the terms were not used according to their usual and different connotations.

Clauses Examples

Example No. 1 (see figure 4)

Reserving all minerals; except coal.

Subject To a 66 foot wide road parcel, Document No. 652, filed February 01, 1906, in the official records of Sherburne County, Minnesota.

Exhibit "A": Attached hereto and made a part of.



SHERBURNE COUNTY, MINNESOTA

NE1/4NE1/4 of Section 21
 T. 35 N., R. 27 W.
 FOURTH PRINCIPAL MERIDIAN

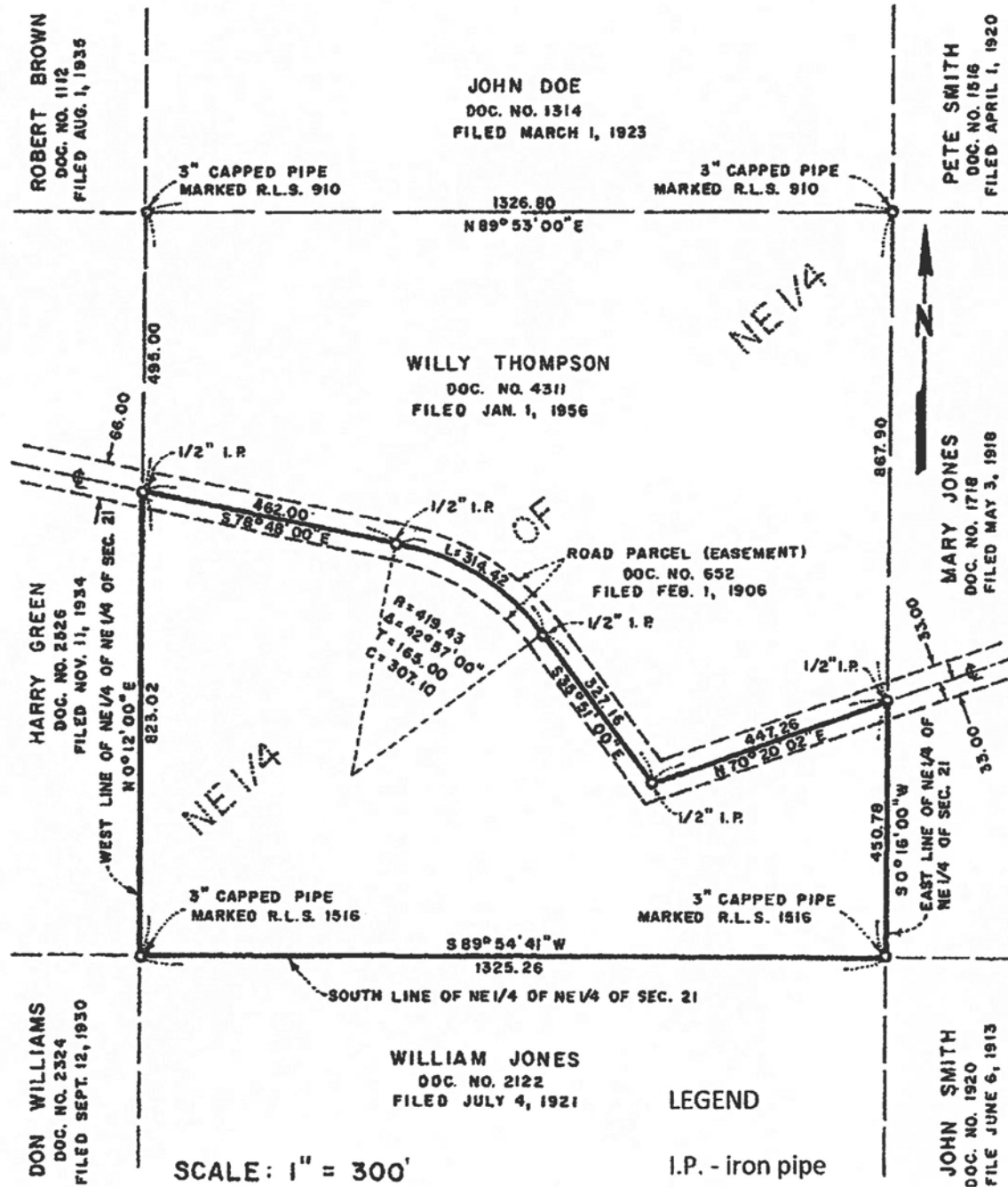

Figure 4. Exhibit "A."

Example No. 2

A portion of land situated in the northwest quarter (NW1/4) of section 15, township 30 north, range 33 west, Seward Meridian, Yukon – Koyukuk Borough, Alaska, being the results of a survey of an irregular bounded portion of land and being more particularly described as follows:

BEGINNING at a 4 inch square hemlock post protruding 24 inches above the ground on the northerly right-of-way line of the Takotna Highway and being 1/4 mile more or less southeasterly from the intersection of said highway line and the left bank of the Kuskokwim River at an approximate latitude of $62^{\circ}52'$ N., longitude $155^{\circ}40'$ W. Said **POINT OF BEGINNING** hereinafter referred to as “Corner No. 1” for this description. From said **POINT OF BEGINNING**, Corner No. 2 of U.S. Survey No. 999 bears N. $26^{\circ} 59'$ W., a distance of 327.6 feet.

THENCE, S. $25^{\circ} 43'$ W., a distance of 1900 feet to a found 4 inch square hemlock post protruding 22 inches above the ground with no markings and accepted as Corner No. 2;

THENCE, S. $57^{\circ} 30'$ W., a distance of 3000 feet to a found 4 inch square hemlock post protruding 18 inches above ground scribed “No. 3”;

THENCE, S. $32^{\circ} 30'$ E., a distance of 830 feet to a found 4 inch square hemlock post protruding 20 inches above ground scribed “No. 4”;

THENCE, N. $57^{\circ} 30'$ E., a distance of 4000 feet to a found 4 inch square hemlock post protruding 24 inches above the ground scribed “No. 5”;

THENCE, N. $25^{\circ} 43'$ E., a distance of 1650 feet to a found 4 inch square hemlock post protruding 20 inches above the ground with no markings and accepted as Corner No. 6;

THENCE, N. $34^{\circ} 17'$ W., a distance of 550 feet to a found 4 inch square hemlock post protruding 22 inches above the ground scribed “No. 7”; and

THENCE, S. $85^{\circ} 38'$ W., a distance of 871.6 feet to the **POINT OF BEGINNING** containing 121.66 acres of land.

BASIS OF BEARINGS – N. $26^{\circ} 59'$ W., being the bearing from said Corner No. 2 of U.S. Survey No. 999 to the **POINT OF BEGINNING** of this survey.

Strip Descriptions

A strip description is a modified form of a metes-and-bounds description used to describe linear features such as a utility corridor or road right-of-way. Strip descriptions are composed with reference to a center line with proper citation of the location and/or width with respect to the described line(s). Since strip descriptions do not describe along the perimeter of a closed figure, they can be used to avoid lengthy land descriptions in certain cases.

The actual composition of a strip description is very similar to a metes-and-bounds description, with some key differences to the caption and body. The caption should contain a citation stating the width of the strip and the position of the described center line. The body is constructed mostly the

same, except the end point of the described line is referred to as the “point of termination,” and no call is made back to the “point of beginning” or the “point of commencement.” The described center line is assumed, by definition, to be located exactly midway between both sidelines, unless stated otherwise. The sidelines are assumed to be perpendicular and parallel to the described line, unless stated otherwise. A qualifying clause should be included to state how the beginnings and ends of the sidelines should be interpreted. For example, property ownership boundaries will seldom be perpendicular to the described line, which if the description is intended to terminate at such property boundaries, will create “gaps” and “overlaps” in the described area. The intended land interest, whether fee, easement, etc., should be stated clearly in a qualifying clause.

Strip Description Example

(see figure 5)

A portion of the east half of the southeast quarter (SE1/4) of section 9, township 45 south, range 11 east, Willamette Meridian, County of Klamath, State of Oregon, and shown in Exhibit “A,” being a 100 foot wide strip of land, the center line of which is more particularly described as follows:

BEGINNING AT A POINT on the line between sections 9 and 10, 694 feet along the section line from the corner of sections 9, 10, 15, and 16. Thence from the **POINT OF BEGINNING**, the following two courses:

- 1) North 40° 56' West, 1468 feet; and
- 2) North 65° 06' West, 395 feet, more or less, to the north and south center line of the southeast 1/4 of section 9 and the **POINT OF TERMINATION**.

The sidelines of said strip shall be lengthened or shortened, as necessary, so as to intersect with the east and west lines of said E1/2SE1/4.

Containing 4.28 acres of land.

The bearings shown herein are based upon the south 1/2 of the line between sections 9 and 10, bearing North 0° 48' East as shown upon the official plat thereof. All distances stated are in U.S. Survey Foot and all bearings are referenced to the true meridian.

The interest to be conveyed is an easement for the purposes of installation and maintenance of an overhead transmission line.

Exhibit “A”: Attached hereto and made a part of.

T. 45 S., R. 11 E., W.M.

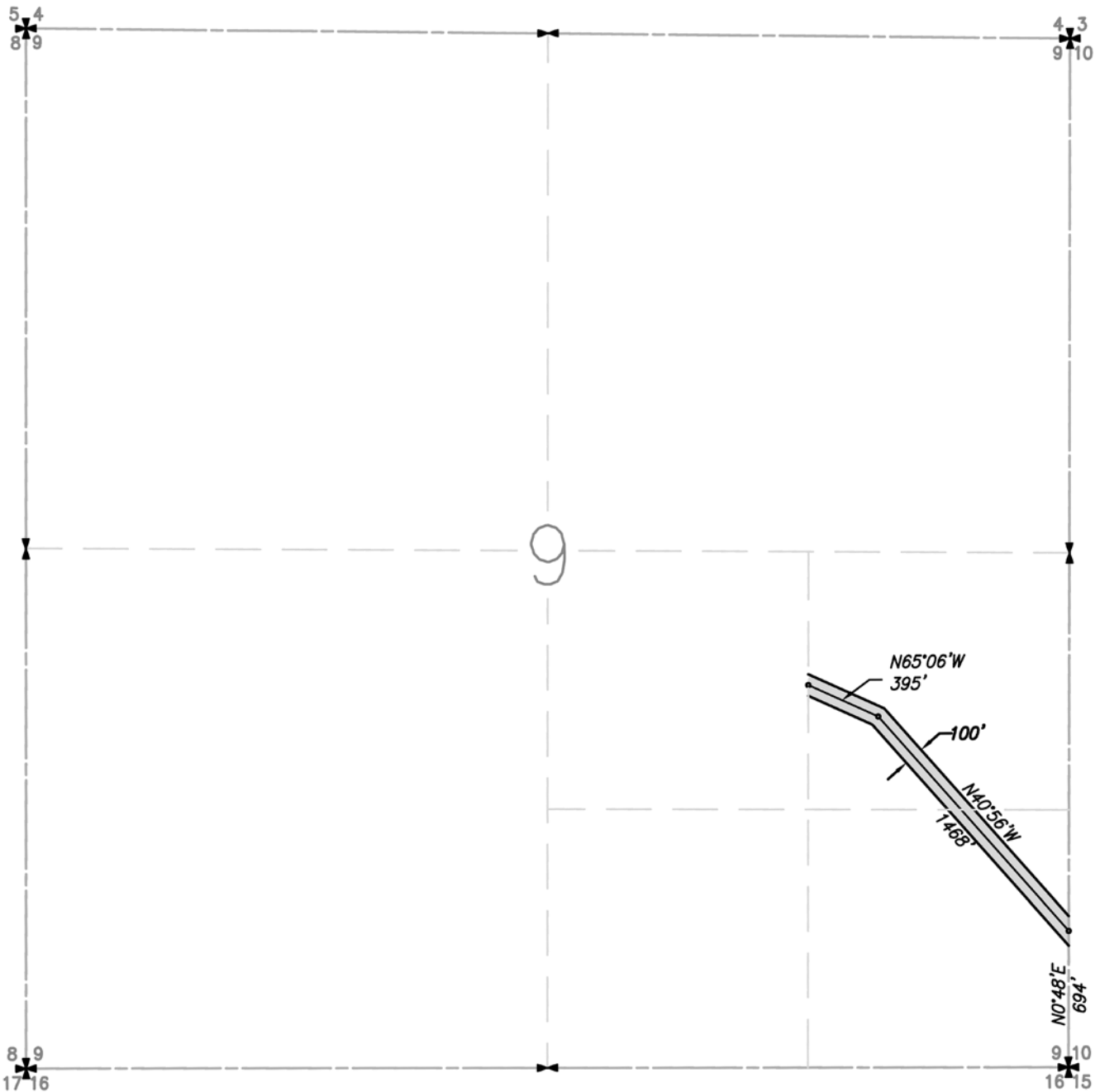

Figure 5. Exhibit "A" (strip description example).

Ambulatory Descriptions

Ambulatory descriptions are those that contain references to described limits that do not have fixed positions or positions that are subject to change over time.

An example is describing land to limits on water boundaries. These descriptions are generally referenced to a specific line along a water body such as the ordinary high water mark, medial line, thread, line of mean high tide, etc. Water boundaries are always subject to change by

natural forces and may add or take land away from an upland owner. Beginning a description from a location that is ambulatory is not advised; a description should begin from another fixed position within the land being described. Descriptions of boundaries running parallel with an ambulatory line must be very specific whether the boundary is ambulatory or fixed. Before a description incorporates a body of water as a boundary, the effects of subsequent movement and whether riparian rights are intended must be considered.

Another example of an ambulatory line would be one not clearly defined to a vertical reference datum or one referenced to natural surface contour lines. If the line is referenced to a qualified vertical reference and straight lines are referenced between physical monuments, the line becomes fixed in its location. When reference to a contour line is used without the clear delineation of its vertical reference or physical monuments and without lines run between the monuments, the line can become ambulatory over time. Natural forces of erosion or accumulation may create an ambulatory situation. For example, 0.5 foot of erosion or accumulation over a period of time on a 1 percent slope could change the horizontal position of the original location by 50 feet. Even if the contour reference is well defined, it would be located in a new position without physical monuments and lines run between the locations for a retraceable boundary. For these reasons, making reference to contour lines of elevation for delimitation of lands should be avoided.

Boundaries involving water bodies can fall within the category of previously described ambulatory descriptions. Describing such boundaries would be similar to, if not the same as, writing a metes-and-bounds description. The difficulties are (a) clearly stating whether the boundary is fixed

or ambulatory and (b) unambiguously describing a boundary that is ambulatory. Descriptions written along the meanders of a water body probably are not describing a fixed boundary line but courses and distances in the near vicinity of the water body to be used for the purpose of calculating closure and computing acreage of the land, with the water body being the boundary. If writing to meanders, including a qualifying clause at the end of the description is prudent to clarify the reason for the meanders and that the boundary is to the actual delineating water boundary, e.g., ordinary high water mark, line of mean high tide, medial line, or thread.

Following are a few excerpt examples of describing water boundaries:

1. Thence, with the meanders of the navigable Johnson Lake the following nine (9) courses and distances:
2. Thence, along the meanders of the shoreline of the Pacific Ocean the following seven (7) courses and distances:
3. Thence, along the center line meanders of nonnavigable Otter Creek the following three (3) courses and distances:
4. Thence, with the meanders of the navigable Truckee River the following six (6) courses and distances:

An example of a qualifying clause follows:

The meanders described within this land description are for the convenience of computing mathematical closure and computing acreage for the described parcel. Actual ownership is to the ordinary high water mark, and the acreage delineated may or may not include the area between the meanders and the ownership boundary.

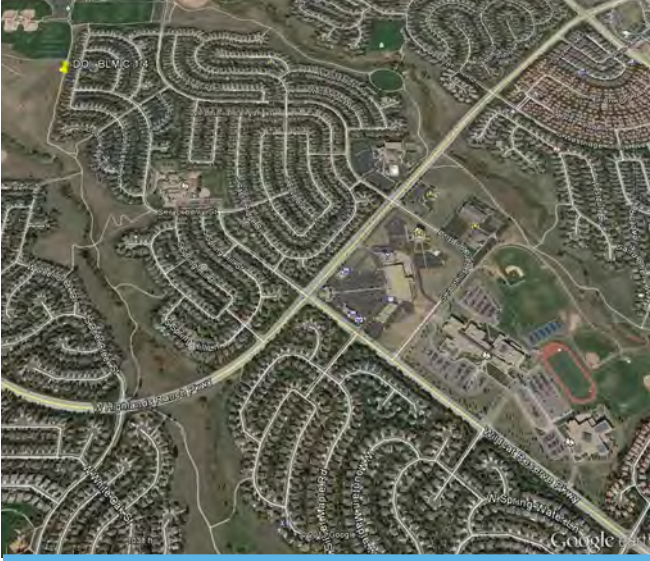

all lot and block descriptions will contain all the elements required for a description listed below. The scrivener and/or the reviewer should ascertain from the subject map or plat the proper elements for a description.

The basic elements are:

1. Lot, parcel, or unit identifier.
2. Block identifier, if applicable (some land divisions may not contain a block identifier).
3. Name or plat/map reference title, e.g., “Sunny Acres Subdivision.”
4. Recording information (which could be file, book, or volume with page number) to include date and location of recordation.
5. County and State.

Example descriptions:

1. Lot 2, Block R, Bandy Subdivision in Book 99, page 10 of official records recorded May 9, 1998, Document No. 10225, El Dorado County, Missouri.
2. Lot 101, Tidelands Subdivision, recorded in File 73, page 23 of County Surveyor Records, dated August 1, 2001, Document No. 555555, Lincoln County, State of California.

Chapter IV—Lot and Block Descriptions

Lot and block descriptions are primarily created within the private sector; however, Federal townsites fall into this category also. These types of descriptions create land divisions of varying acreage sizes commonly referred to as “lots” and generally have a “lot” identifier that could be numeric or alpha characters or a combination thereof. When the map creates these divisions, they are commonly referred to as a “simultaneous conveyance.” In reality there may not be any conveyance performed at all and the process simply has created multiple divisions of land at the same moment in time, similar to sections returned on the same official rectangular survey plat of the General Land Office (GLO) or the BLM. Not

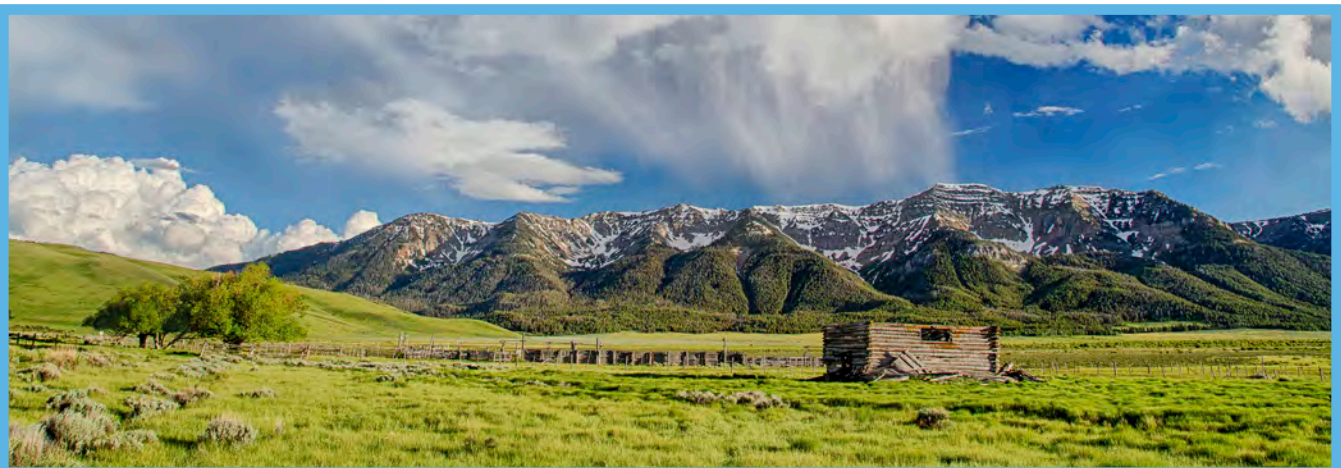



Chapter V—Illustrations (Maps) and Coordinates

Maps to be Published

Under some conditions, incorporating a plat, map or diagram as an integral part of a land order or proclamation, either in place of or in addition to a written description, is essential.

Federal Register regulations (1 CFR 18.10) apply to the preparation of documents required to be filed in the Office of the *Federal Register* for publication:

- (a) If it is necessary to publish a form or illustration, either a clear and legible original form or illustration or a clear and legible 8½ by 11 inch reproduction shall be included in the original document and each certified copy.
- (b) A document that includes tabular material may be assigned to the deferred publication schedule. See § 17.7 [1 CFR 17.7].

The Office of the *Federal Register* encourages Federal agencies to submit all notices and any

accompanying maps and illustrations as electronic files together with the original documents and certified copies. When submitting maps or illustrations, the map or illustration should be inserted in the same electronic file that contains the notice and in the approximate location where the map or illustration is to appear.

Preparation

The following should be observed in preparing the plat, map, or diagram (see figure 6 for example):

- (a) The title should be identical to that of the land order or proclamation insofar as practicable.
- (b) The date should be the same as that of the land order or proclamation.
- (c) Two or more parallels and meridians, with the latitude and longitude of each, should be shown where the size of the tract warrants; otherwise the latitude and longitude of one point and an orientation arrow should be shown.
- (d) The plat, map, or diagram should carry an appropriate graphic scale.
- (e) The lines and lettering should be in black only and legible when reduced for publication.
- (f) The name of the originating bureau or agency, list of sources, and a statement that the plat, map, or diagram is attached to and forms a part of the land order or proclamation should be shown.

The text of the land order or proclamation should include a clause, reading substantially as follows:

... the boundaries (or tract) shown upon the (survey plat) (map) (diagram) attached hereto and made a part hereof . . .

Officially Filed
DATE DEC 10, 2010

ORIGINAL

**U. S. SURVEY
NO. 20500, ALASKA
AND THE RETRACEMENT OF
U. S. SURVEY NO. 19500**

This plat contains the entire survey record.
The survey of U. S. Survey No. 19500, was executed, under contract, by Daniel E. Boone, Alaska Registered Land Surveyor, No. 101, in 2004.

The direction and length of lines were determined by Global Positioning System (GPS) Real-Time Kinematic (RTK) observations. All bearings were measured with reference to the true meridian. All bearings are true mean bearings. All distances are horizontal distances reduced to their sea level equivalent. No lines were brushed or marked between corners.

This survey was executed by Yeomar W. Trebborski, Cadastral Surveyor, September 1 through September 2, 2010, in accordance with the specifications set forth in the Manual of Surveying Instructions, 2009. Special Instructions dated April 20, 2010, approved May 24, 2010, and Assignment Instructions dated May 26, 2010.

Field assistant was:
Justin T. Case, Land Surveyor

Area Surveyed: 80.00 Acres

The geographic position of the witness corner to corner No. 1, U. S. Survey No. 20500, a meander determined by GPS observation utilizing the National Geodetic Survey Online Positioning Users Service (NPOS), to a Network Accuracy with a maximum computed position of less than 0.05 meter, as defined in the Bureau of Land Management's Standards for the Positional Accuracy of Cadastral Surveys When Using Global Navigational Satellite Systems (GNSS), dated February 23, 2009, is:

Latitude: 55° 58' 28.346" North
Longitude: 158° 42' 10.664" West

The mean magnetic declination was derived from the U. S. Department of Defense World Magnetic Model 2010.

This survey is situated along the southerly shore of Mitrofanina Harbor, approximately 17 1/2 miles northeasterly of Perryville, within unsurveyed Township 48 South, Range 60 West, Seward Meridian, Alaska.

The terrain is level to very steep, with several rocky outcrops. Elevation varies from 0 to 250 feet above sea level. Vegetation consists of alder and willow brush, mixed with grass and abundant salmon berries.

Access to the survey was by boat.

UNITED STATES DEPARTMENT OF THE INTERIOR
BUREAU OF LAND MANAGEMENT
Anchorage, Alaska

The survey represented by this plat, having been correctly executed in accordance with the requirements of, and the regulations of this Bureau, is hereby accepted.

For the Director
/s/ Signature November 24, 2010
Date

Chief Cadastral Surveyor for Alaska

Set a stainless steel post, 28 in. long, in the ground, with brass cap m.d. as shown.

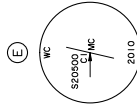

Set a stainless steel post, 28 in. long, in the ground, with brass cap m.d. as shown.

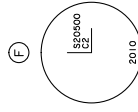

Set a stainless steel post, 28 in. long, in the ground, with brass cap m.d. as shown.

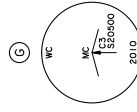

Found a stainless steel post, 2 1/2 in. in diam., projecting 8 in. above the ground, with brass cap m.d. S13345 L2 C2 2004.

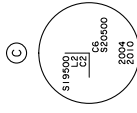

Found a stainless steel post, 2 1/2 in. in diam., projecting 8 in. above the ground, with brass cap m.d. MC MC C1 L2 S13345 2004, and an arrow pointing to the true point.

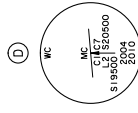

A magnetic disturbance was detected at the record position of the original magnetic accessories.

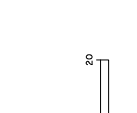

Found a stainless steel post, 2 1/2 in. in diam., projecting 8 in. above the ground, with brass cap m.d. S13345 L2 C3 2004, and an arrow pointing to the true point.

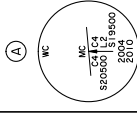

The original alum. rod, 3/4 in. diam., firmly set, projecting 8 in. above the ground, with brass cap m.d. S13345 L2 C4 2004, and an arrow pointing to the true point.

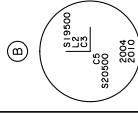

Magnetic disturbances were detected at the record positions of the original magnetic accessories.

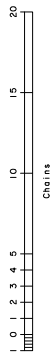
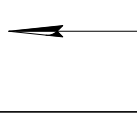

MEANDERS
Along a well-defined, rocky shoreline, at the line of mean high tide.

1. S. 75° 03' E., 1.36 ch.
2. S. 82° 21' E., 1.19 ch.
3. N. 84° 43' E., 3.86 ch.
4. S. 85° 49' E., 1.95 ch.
5. S. 72° 25' E., 1.41 ch.
6. S. 76° 03' E., 1.55 ch.
7. N. 86° 29' E., 1.27 ch.
8. S. 71° 35' E., 1.66 ch.
9. N. 80° 15' E., 0.85 ch.
10. S. 35° 42' E., 0.41 ch.
11. S. 42° 21' E., 1.68 ch.
12. S. 74° 01' E., 4.29 ch.
13. S. 39° 38' E., 0.99 ch.
14. S. 41° 30' E., 1.91 ch.
15. S. 22° 42' E., 1.06 ch.
16. S. 07° 10' E., 2.06 ch.
17. S. 12° 45' E., 0.82 ch.
18. S. 45° 30' E., 1.37 ch.
19. S. 15° 32' W., 0.87 ch.

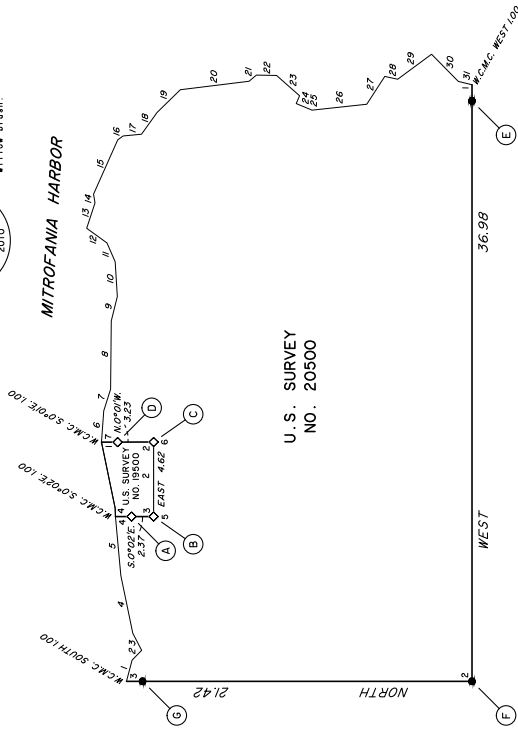

**PERRYVILLE RECREATION AREA
SURVEY ATTACHED TO AND FORMING PART
OF PUBLIC LAND ORDER 0000
DATED JANUARY 30, 2011**

I, Yeomar W. Trebborski, HEREBY CERTIFY upon honor that I have executed the survey depicted on this plat in strict conformity with said Special Instructions, the Manual of Surveying Instructions, 2009, and in the specific manner described on this plat.

NOVEMBER 18, 2010
Date
/s/ Signature Cadastral Surveyor

JWT

Figure 6. Federal Register illustration.

Survey Plats, Maps, or Diagrams Forming Official Supplements

Where the reduction in scale is so great as to impair the legibility of the plat, map, or diagram, the publication of the land order or proclamation should be avoided. In such cases, it is preferable to file a full-scale plat, map, or diagram as an official supplement with a duplicate copy filed with the Secretary's copies in the public lands records. The principle that an official plat, map, or diagram cited in a deed or other document is in fact a part of such a document as if incorporated in it has already been referred to in chapter I.

This principle (of description by reference) may be used under these conditions by the originating bureau or agency. A properly identified plat, map, or diagram supplement, bearing the certificate of an officer of the bureau or agency, may be placed on record in the appropriate Federal files.

A file of plats, maps, or diagrams that serve as official supplements to land orders or proclamations should comply with the following requirements:

1. The plats, maps, or diagrams should be adequately indexed, classified, and described.
2. They should be available for inspection and consultation by interested persons.
3. Copies of the plats, maps, or diagrams should be available for sale to the public at uniform listed prices.

Full-scale copies of these plats, maps, or diagrams may be folded and attached to printed copies of land orders and proclamations for administrative use or for sale at uniform listed prices to interested persons.

Where official supplements are used, the text of the land order or proclamation should include a statement reading substantially as follows:

The boundaries (or tract) described (or referred to) are shown upon _____

 _____ (bureau or agency) (survey plat or map or diagram) entitled _____,
 dated _____, filed in _____
 _____ (place of filing), supplementing this land order (or proclamation).

Description by Coordinates

The location of a point on the surface of the earth may be accurately described by expressing its position on any well-established system of coordinates.

Two general classes of coordinates are available for such use in the United States: geographic positions (latitudes and longitudes) and plane-coordinate (x and y) positions which are derived from and are dependent upon geographic positions.

A point can be reestablished after its coordinates have been determined. Every geographic coordinate pair should be defined by the datum, date of adjustment or epoch date, and the geoid model used. If coordinates are reported in a projection, the projection used, as well as the previously stated attribute data, will be stated (see figure 7 for example). However, great care must be exercised to ensure that the original coordinate pairs were produced by a process that is repeatable within a quantifiable accuracy standard. Occasionally, coordinates can be the best available evidence for the position of a point if the coordinate data is determined and reported with an adequate degree of precision.

Geographic Positions

The United States is covered by a network of triangulations and traverses, which determines the latitudes and longitudes of thousands of marked points based on a standard geodetic datum known as the North American Datum of 1983 (NAD 83).

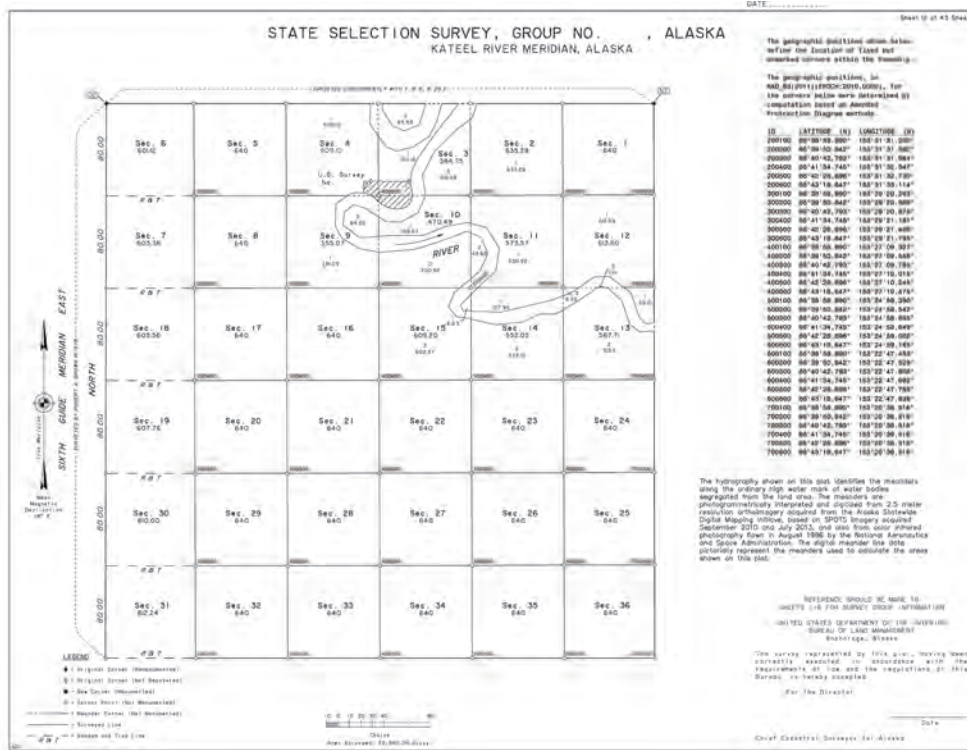

Figure 7. Protraction diagram.

In addition, a network of continuously operating reference stations (CORS) provides for global positioning system (GPS) code range and carrier phase data in support of 3-dimensional positioning activities.

The sum is the National Spatial Reference System (NSRS), which is the official system of the Federal Government that allows users to determine geodetic latitude, longitude and height, plus orthometric height, geopotential, acceleration of gravity, and deflection of the vertical at any point within the United States or its territories. The responsible agency for this network is the National Geodetic Survey (NGS), National Oceanic and Atmospheric Administration (NOAA), Department of Commerce.

As NAD 83 superseded earlier datums, it is essential that all computations and recorded values on a geodetic datum be accompanied by a legend identifying the datum used. There is nothing in the form of a geographic position itself to identify it as being on a certain geodetic datum or as an independent astronomical position.

The earth is dynamic, meaning that every point has some movement, called velocity, relative to other points. Therefore, all new coordinates of defining points of the NSRS will have an epoch tag. In particular, an epoch-tagged set of coordinates will identify the date and instant corresponding to the position of a coordinate system, with all subsequent positions being referred to the position at that epoch. In this sense, an epoch tag is equivalent to a date. Descriptions are created for different purposes and providing a significantly higher degree of geographic position accuracy than is necessary can be a wasted effort.

Awareness of the relative accuracy that is rendered by the values displayed for the latitude and longitude coordinates is essential. A rough rule of thumb is that every second of arc equals 100 feet of position change. This rule is consistent with latitude values; however, with longitude values, this distance decreases due to convergence of the meridians as distance progresses north or south from the equator to the poles. Providing values to the nearest second results in a positional accuracy of +/- 100 feet, to the nearest 1/10 of a second

results in a positional accuracy of +/- 10 feet, to the nearest 1/100 of a second results in a positional accuracy of +/- of 1 foot, and to the nearest 1/1000 of a second results in a positional accuracy of +/- 1/10 of a foot, etc.

If the geographic position is referenced by a physical monument or natural feature, the preceding could become irrelevant, but if position only with no physical reference is given, it could be perceived to be within the positional tolerances described. Making the intent of the positional accuracy for the latitude and longitude coordinate clear is important.

Where a boundary is defined by expressing the geodetic latitudes and longitudes of its corners, the forward and back azimuths and the lengths of the lines forming the boundary should also be given. This data should be arranged in the tabular form

generally adopted for such data by the various Federal survey bureaus. The descriptions of the station and corner sites and of their monuments and marks should follow the table of positions and be in short paragraphs arranged in the same sequence as the positions.

While considered a complete, legal, and satisfactory description, many state laws may not require a party to a real property transaction to rely wholly on a description, any part of which depends exclusively upon coordinates or geographic positions.

Obtaining a statement from the appropriate cadastral survey office relative to the appropriate coordinates to be employed is advisable. If you have questions about geographic coordinates, contact your local cadastral survey office.

Examples of Geographic Coordinate Positions

(note decimal accuracy of the coordinates)

Example No. 1

Witness Corner to Meander Corner No. 1, U.S. Survey No. 14280, Alaska

NAD 83 (2011)	–	62°59'14.370" (N)	144°29'00.461" (W)
EPOCH DATE	–	2010.00	

Example No. 2

Southeast Corner of Township 16 South, Range 15 East, Umiat Meridian, Alaska

NAD 83 (2011)	–	68°00'22.214" (N)	148°32'23.603" (W)
EPOCH DATE	–	2010.00	

The geographic positions, in NAD 83 (2011), epoch 2010.00, for the corners above were determined by GPS observations, using the National Geodetic Survey (NGS) Online Positioning User Service (OPUS), to a network accuracy, with a maximum peak-to-peak separation for each component of the

computed position of less than 0.05 meters, semi-major axis 95 percent error ellipse, as defined in the current *Standards for the Positional Accuracy of Cadastral Surveys When Using Global Navigation Satellite Systems*.



Chapter VI—Form and Arrangement

Executive Order No. 11030 of June 19, 1962, as amended by Executive Order No. 11354, May 23, 1967; Executive Order No. 12080, September 18, 1978; and Executive Order No. 12608, September 9, 1987, under section one, prescribe certain requirements in connection with the preparation of Executive orders and proclamations. Land descriptions of such documents should follow these requirements and also incorporate the guidance found in other Executive orders, regulations, and policies.

Executive Order No. 11030, as Amended—Preparation, Presentation, Filing, and Publication of Executive Orders and Proclamations

By virtue of the authority vested in me by the *Federal Register* Act (49 Stat. 500, as amended; 44 U.S.C. § 301 *et seq.*), and as President of the United States, I hereby prescribe the following regulations governing the preparation, presentation, filing, and publication of Executive orders and proclamations:

Section 1. Form. Proposed Executive orders and proclamations shall be prepared in accordance with the following requirements:

- (e) Descriptions of tracts of land shall conform, so far as practicable, to the most recent edition of the “Specifications for Descriptions of Tracts of Land for Use in Executive Orders and Proclamations,” prepared by the Bureau of Land Management, Department of the Interior.

Section 2. Routing and approval of drafts.

- (d) After determining that the proposed Executive order or proclamation conforms to the requirements of Section 1 of this order and is free from typographical or clerical error, the Director of the Office of the *Federal Register* shall transmit it and three copies thereof to the President.

[History and authority: The provisions of Executive Order No. 11030 of June 19, 1962, appear at 27 FR 5847, 3 CFR, 1959-1963 Comp., p. 610, unless otherwise noted.]

1 CFR 18.10—Illustrations, Tabular Material, and Forms

The guidance found in the Title 1, Part 18, of the Code of Federal Regulations (CFR) is applicable to all documents filed with the *Federal Register*, including plats and maps:

§ 18.10 Illustrations, tabular material, and forms.

- (a) If it is necessary to publish a form or illustration, a clear and legible original form or illustration, or a clear and completely legible reproduction approximately 8½ by 11 inches, shall be included in the original document and each certified copy.

[History and authority: 54 FR 9681, Mar. 7, 1989; 44 U.S.C. § 1506, sec. 6, E.O. 10530, 19 FR 2709; 3 CFR, 1954-1958 Comp., p. 189.]

1 CFR 19.1—Form

Pertinent to the requirement in Executive Order No. 11030, as amended, regulations prescribed by the order are codified under Title 1, Part 19 of the Code of Federal Regulations and are applicable to all proposed Executive orders and proclamations:

§ 19.1 Form.

Proposed Executive orders and proclamations shall be prepared in accordance with the following requirements:

- (e) Descriptions of tracts of land shall conform, so far as practicable, to the most recent edition of the “Specifications for Descriptions of Tracts of Land for Use in Executive Orders and Proclamations,”²⁶ prepared by the Bureau of Land Management, Department of the Interior.

[History and authority: 37 FR 23610, Nov. 4, 1972, as amended at 54 FR 9681, Mar. 7, 1989; E.O. 11030, secs. 1 to 6, 27 FR 5847, 3 CFR, 1959-1963 Comp., p. 610; E.O. 11354, 32 FR 7695, 3 CFR, 1966-1970 Comp., p. 652; and E.O. 12080, 43 FR 42235, 3 CFR, 1978 Comp., p. 224.]

43 CFR 2300—Land Withdrawals, Reservations, and Classifications of Land

The Federal Land Policy and Management Act²⁷ and Executive Order No. 10355²⁸ delegate authority regarding the withdrawal, reservation, and classification of lands to the Secretary of the Interior. The land description portion of applications, proposals, petitions, and orders

²⁶ Agencies with computer processed data are urged to consult with the Office of the *Federal Register* staff about possible use of the data in the publication process.

²⁷ 43 U.S.C. 1714; 43 CFR 2300.0-3(a)(1).

²⁸ 43 CFR 2300.0-3(a)(2).

for the making, modification, relinquishment, revocation, extension, correction, review, and termination of withdrawals or reservations is required to be suitable for publication in the *Federal Register*.

§ 2300.0-5 Definitions

- (n) *Legal description* means a written land description based upon either an approved and filed Federal land survey executed as a part of the United States Public Land Survey System or, where specifically authorized under Federal law, upon a protraction diagram. In the absence of the foregoing, the term means a written description, approved by the authorized officer, which defines the exterior boundaries of a tract of land by reference to a metes and bounds survey or natural or other monuments.

The acreage listed in the applications, proposals, petitions, and orders for the making, modification, revocation, or extension of a withdrawal or reservation shall be based upon the actual acreage as shown upon the official plats of survey, diagrams or maps used for the written land description.²⁹ In the absence of the foregoing the acreage used shall be approved by the authorized officer.

Land classification land descriptions are systematically reviewed as part of the BLM’s withdrawal program.

[History and authority: 43 CFR Group 2300, 35 FR 9558, June 13, 1970; 42 FR 28721, June 3, 1977; 46 FR 5796, Jan. 19, 1981; E.O. 10355, May 28, 1952, 17 FR 4831, 3 CFR, 1949-1953 Comp., p. 873; 43 U.S.C. §§ 2, 1201, 1714 (FLPMA sec. 204), and 1740.]

²⁹ 43 CFR 2310.1-3(b)(3).

Department of the Interior Secretary's Orders

Section 1.3D of Departmental Manual Part 012, “Secretary’s Orders,” Chapter 1, “Preparation and Issuance of Secretary’s Orders,” requires that proposed orders containing a description of land, drafted by other than the BLM, will be referred to that Bureau for review of the accuracy and sufficiency of the description. The BLM’s policy is to coordinate this review through its cadastral survey program.

Public Land Orders

A public land order should be prepared in a form as set forth in the BLM’s *Preparation of Public Land Orders and Associated Documents* guidance. Land descriptions must be in conformance with the guidance contained in this edition of the *Specifications for Descriptions of Land*.

Executive Order No. 13327—Federal Real Property Asset Management

Section 1. Policy. It is the policy of the United States to promote efficient and economical use of America’s real property assets and to assure management accountability for implementing federal real property management reforms.

Section 5(c) states that a single, comprehensive, and descriptive database of all real property under the custody and control of all executive branch agencies shall be maintained. It also states that descriptive information, except for classified information, that is considered the best available to describe the nature, use, and extent of the real property holdings of the Federal Government, shall be collected from each executive branch agency.

Marine Managed Areas: Best Practices for Boundary Making

This manual, written by the FGDC Marine Boundary Working Group, should be referenced for marine boundary delimitation and for developing those boundaries within a digital environment. It offers the following guidance to boundary developers:

“This manual attempts to provide guidelines to reduce boundary misunderstandings and litigation. Haste, inexperience, and lack of consulting with boundary experts are common reasons for poor boundary development. The lesson that this experience teaches is important: boundary developers must resolve or account for all boundary issues before they can develop effective boundaries. Heeding this advice and employing best technical practices are beneficial to creating effective marine boundaries.”



Appendix: Introductions to Previous Editions

1979 Edition

Certain procedures have been rendered inapplicable due to reorganizations and transfer of functions of various Federal agencies. The issuance of certain Executive Orders and the enactment of Public Law 94-57[9], Federal Land Policy and Management Act of 1976, 90 Stat. 2743 have introduced numerous changes.

A general revision has been found necessary and work was undertaken by the Bureau of Land Management in 1979.

1960 Edition

This edition of “Specifications for Descriptions of Tracts of Land for Use in Executive Orders and Proclamations” was issued in 1931, revised in 1942, and reprinted without change pending revision April 1960.

1942 Edition

This revision of “Specification for Descriptions of Tracts of Land for Use in Executive Orders and Proclamations” issued in 1931 and reprinted in 1941 is published through the cooperation of the Commissioner of the General Land Office, United States Department of the Interior.

In 1930 the Department of State requested the Federal Board of Surveys and Maps to prepare rules and specifications for descriptions of tracts of land appropriate for use in Executive orders and proclamations. The preparation of these specifications was undertaken by the following members of the Board’s Committee on Cadastral Surveys:

- A. D. Kidder, General Land Office, Chairman;
- S. W. Boggs, Department of State;
- C. H. Squire, Forest Service;
- W. T. Paine, General Land Office.

The original edition, entitled “Specifications for Descriptions of Tracts of Land for Use in Executive Orders and Proclamations,” was completed and published in 1931, and reissued, with some corrections as to procedure, in 1941.

The functions connected with the preparation and presentation of Executive orders and proclamations, formerly performed by the Department of State, are now carried on by the Division of the *Federal Register*, the National Archives, under the provisions of the *Federal Register Act*, approved July 26, 1935. This has introduced certain changes in procedure and requirements and has rendered inapplicable some of the material contained in the first edition. Further experience in the use of the specifications during the ten-year period which has elapsed since their first publication has indicated the need for additional explanatory text and examples.

A general revision of the publication was, therefore, found advisable, and the work was undertaken in 1940, 1941 and 1942 by the following members of the Board's Committee on Cadastral Surveys and Maps:

W. H. Richards, General Land Office, Chairman;
S. W. Boggs, Department of State;
J. E. Burch, Forest Service;
H. C. Mitchell, U.S. Coast and Geodetic Survey;
P. A. Rosendorn, Bureau of Reclamation;
J. M. Stewart, Office of Indian Affairs.

The revision was nearly complete on March 10, 1942, when the functions of the Federal Board of Surveys and Maps were transferred to the Director of the Bureau of the Budget by Executive Order No. 9094. The completion of this work and the publication of this edition were carried out at the request of the Bureau of the Budget.

1941 Edition

This edition is a re-issue under the supervision and approval of the Federal Board of Surveys and Maps in cooperation with the Commissioner of the General Land Office, Department of the Interior, to supplement the original issue of 1931, the stock of which is exhausted, pending a more general revision and the preparation of new material.

Corrections that show the current practice are indicated by marginal and footnote references; the principal amendments are set out on pages 3 and 33.

CERTIFICATE
No. 6496

THE UNITED STATES OF AMERICA,

To all to whom these Presents shall come, Greeting:

WHEREAS

Abraham Lincoln of Hancock County Illinois

has deposited in the **GENERAL LAND OFFICE** of the United States, a Certificate of the **REGISTER OF THE LAND OFFICE** at *Quincy*

whereby it appears that full payment has been made by the said

Abraham Lincoln

according to the provisions of

the Act of Congress of the 24th of April, 1820, entitled "An Act making further provision for the sale of the Public Lands," for

the North West quarter of the South West quarter of Section twenty five, in Township six North of the baseline, of Range six West of the fourth principal Meridian in the District of lands subject to sale at Quincy, Illinois, containing forty acres,

according to the official plat of the survey of the said Lands, returned to the General Land Office by the **SURVEYOR GENERAL**, which said tract has been purchased by the said *Abraham Lincoln*

NOW KNOW YE, That the

United States of America, in consideration of the Premises, and in conformity with the several acts of Congress, in such case made and provided, **HAVE GIVEN AND GRANTED**, and by these presents **DO GIVE AND GRANT**, unto the said *Abraham Lincoln*

and to *his* heirs, the said tract above described: **TO HAVE AND TO HOLD** the same, together with all the rights, privileges, immunities, and appurtenances of whatsoever nature, thereunto belonging, unto the said

Abraham Lincoln

and to *his* heirs and assigns forever.

In Testimony Whereof, *Martin Van Buren*

PRESIDENT OF THE UNITED STATES OF AMERICA, have caused these Letters to be made **PATENT**, and the **SEAL** of the **GENERAL LAND OFFICE** to be hereunto affixed.

GIVEN under my hand, at the **CITY OF WASHINGTON**, the *third* day of *November*

in the Year of our Lord one thousand eight hundred and *forty* and of the

INDEPENDENCE OF THE UNITED STATES the *fifty*th

BY THE PRESIDENT:

Martin Van Buren

By

M. Van Buren Jr Sec'y.

J. S. Wilson Acting **RECORDER of the General Land Office,**
ad interim

